

THE EXPERIENCE



Q DISPLAY SERIES 2

User guide

TABLE OF CONTENT

Welcome to the Q Experience 2.0	9
Making boating easier and smarter	9
Keep your boat safe with the Q Mobile App	9
Important information	10
FCC Compliance statement	10
FCC Interference statement	10
ISED Canada compliance statement	10
Déclaration de conformité d'Innovation, Sciences et Développement économique Canada	10
Introduction	11
1. Sidebar	12
Home button	12
Pinned views	13
Notification centre and Notifications	14
System updates	14
System status area	14
2. View	15
3. Application	16
4. Home menu	17
4.1. Views	18
Default and custom views	18
4.1.1. Manage views	19
4.1.2 Reset views	20
4.1.3 Split view	20
4.2 Utilities	21
5. Map	22
5.1 Map basics	23
5.1.1 Panning	23
5.1.2 Centering	23
5.1.3 Zooming	23
5.1.4 Measure distance	23
5.1.5 View location information	23
5.2 Location properties	24

5.2.1 Location information	24
5.2.2 Set as destination	24
5.2.3 Save to My Places / Edit place	24
5.2.4 What's here?	24
5.2.5 Move the position	24
5.2.6 Center to	24
5.3 Navigation / Set a destination	25
5.4 Map's application menu	26
1. Map menu	26
2. Search	26
3. Chart settings	26
4. My places	26
5. My routes	26
6. Log	27
7. Place here	27
8. Radar settings	27
9. Compact dashboard widget settings	27
10. Utility menu	27
5.5 Chart settings	28
Chart orientation	28
Heading line	28
Show trail	28
Autocentre	28
Autozoom speed limit	28
Low speed zoom level	28
Easy view™	29
SonarChart™	29
2D shading	29
Community edits	29
Chart details	29
Satellite overlay	29
Satellite overlay opacity	29
Default zoom level	30
Safe water depth	30
Shallow water depth	30
Spot soundings	30
Depth contours	30
Minimum fishing range	30
Maximum fishing range	30
Reset chart settings	30
5.6 Location and route properties	31

5.6.1 Set as destination	31
5.6.2 Edit place	31
5.6.3 Plan route from here	31
5.6.4 What's here?	31
5.6.5 Centre to	31
5.6.6 Remove	31
5.7 Route properties	32
5.7.1 New route	32
5.7.2 Route information	32
5.7.3 Start navigation	32
5.7.4 Show on chart/Hide from chart	32
5.7.5 Edit route	32
5.7.6 Centre to	32
5.7.7 Remove route	32

6. Dashboard 33

6.1 Dashboard app	33
6.2 Dashboard Settings	34
Dashboard's application menu	34
RPM	35
Engine temperature	35
Trim level	35
Engine hours	35
Alternator Voltage	35
Trolling	35
Throttle level	35
Throttle state	35
Output power (Only for electric propulsion)	35
Engine voltage (Only for electric propulsion)	35
Consumption	36
Economy	36
Fuel level	36
Battery voltage	36
AUX battery voltage	36
Battery temp (Only for electric propulsion)	36
Battery SOC (Only for electric propulsion)	36
Speed	37
Speed conversion	37
Position	37
COG	37
Heading (Requires additional sensor)	37
Compass	37

Depth (Requires additional sensor)	37
Water temp (Requires additional sensor)	37
Target direction	37
Wind (Requires additional sensor)	37
Range estimation	37
Current trip	38
User trip A	38
User trip B	38
To the destination	38
Audio volume	38
Radar range	38

7. Compact dashboard widget **39**

1. Compact dashboard	39
2. Compact dashboard activations in the application menu button	39

8. Fishfinder **40**

Fishfinder menu	40
Sonar channel	41
Gain mode	41
Smoothing mode	41
Filter mode	41
Depth levels	41
Seabed enhancing	41
Depth lines	41
Visible horizon	41
Automatic scrolling	41
Scrolling speed	41
CHIRP color scheme	41
DownVision color scheme	41
Automatic noise rejection	42
Automatic sensitivity	42
Automatic range	42
Depth levels	42
Color scheme	42
Seabed enhancing	42
Depth lines	42
Automatic scrolling	42
Visible horizon	42
Scrolling speed	42

9. Radar **43**

1. Radar menu	43
Heading mode	43
Reflection color	43
Power	44
Preset	44
Increase/Decrease range	44
Gain	44
Sea clutter	44
Rain clutter	44
Radar offset	44
2. Radar controls	44
10. Music	45
Music player area	45
Music menu	46
Radio input and Favourites	46
Bluetooth input	47
Aux input	48
Equalizer	48
11. Weather	49
12. Info	50
13. Settings	51
13.1 System settings	52
1. System info	52
2. Language	52
3. Time offset/automatic time zone	52
4. Demonstration mode	52
5. Display QR code	52
13.2 Users	53
1. Change user	53
2. Add new user	53
3. Remove current user	53
4. User selection time	53
13.3 Display settings	54
1. Handedness	54
2. Display brightness	54
3. Theme	54
4. Automatic night mode	54
5. Night mode	54

6. Text size	54
7. No automatic shutdown	54
13.4 Navigation	55
1. GPS information	55
2. GPS Source	55
3. Magnetic heading correction	55
4. Trail length	55
13.5 WLAN	56
1. WLAN ON/OFF	56
2. Networks	56
3. Hotspot ON/OFF	56
4. Hotspot SSID	56
5. Hotspot password	56
13.6 Bluetooth	57
1. Bluetooth toggle	57
2. Devices	57
3. Device name	57
4. Q Remote	57
13.7 Mobile data	57
13.8 Boat settings	58
Engine count	58
Boat draft	58
Boat width & height	58
Propulsion type	58
Fuel level stabilization	58
Extra packages	58
Fuel tank capacity	58
Fuel sensor 1 & 2 input	58
Trim calibration	58
Speed update interval	58
13.9 Unit settings	59
1. Date format	59
2. Distance	59
3. Length	59
4. Speed	60
5. Show speed decimal	60
6. Depth	60
7. Temperature	60
8. Volume	60
9. Position	60
10. Wind speed	60

13.10 Audio settings	61
1. Volume	61
2. Zone 1 & 2 volumes	61
3. Equalizer	61
4. Radio mode	61
13.11 System reset	61

14. Q mobile app **62**

WELCOME TO THE Q DISPLAY 2.0

Make sure to read this guide to get the most out of your Q Experience.

The Q Experience brings easy-to-use smart navigation to your boat, making boating and navigation easier and smarter for everyone. This smart navigation system is more than just a regular plotter. It brings everything you need together, from navigation to entertainment, and displays it clearly and accessibly at your fingertips.

Your new Q Display has been designed with usability as a priority. It has a clear and bright waterproof touchscreen, easy-to-read navigation menus and configurable shortcuts for swift control of your boat while on the move. You can control your boat's navigation, heating, music, Fishfinder, radar etc. all with the same device.

The Q Display Series 2 product family includes four plotter sizes:

- » Q Display 210 (10")
- » Q Display 212 (12")
- » Q Display 216 (16")
- » Q Display 210D (Double 10")

They all have the same general functions, introduced in this user guide.

Making boating easier and smarter

The Q Display is customizable to your liking. You can pin the things you need the most to the sidebar on the right side of your Q Display. By creating split-views you can make multitasking easier than ever before. With your own view shortcuts, you spend less time setting up your display, and more time boating.

The Q Experience takes safety with the utmost seriousness.

The Q Display's bright screen will keep you on the map, wherever you go. The Q Display will warn you against bad weather approaching, to allow you to avoid storms and rough seas.

Keep your boat safe with the Q Mobile App

The Guard feature, that you can find in the Q Experience app, keeps your boat safe while on the docks. It will alert you if the boat is filling up with water or if there is a boat theft.

The Q Experience mobile app also always keeps all your boating info with you, wherever you go. You can download it from your phone's app store.

NOTE: Buster, Yamarin, and Yamarin Cross boats use their own Buster Q and Yamarin Q mobile apps.

Notice! You can access this guide any time from your plotter's Home menu > Info > Guides

IMPORTANT INFORMATION

FCC Compliance statement

Changes or modifications not expressly approved by Nextfour Solutions Oy could void the user's authority to operate the equipment.

This device complies with Part 15 of FCC Rules. Operation is subject to the following two conditions:

1. This device may not cause harmful interference.
2. This device must accept any interference received, including interference that may cause undesired operation.

FCC Interference statement

This equipment has been tested and found to comply with the limits for a Class B digital device, pursuant to part 15 of the FCC Rules.

These limits are designed to provide reasonable protection against harmful interference in a residential installation. This equipment generates, uses and can radiate radio frequency energy and, if not installed and used in accordance with the instructions, may cause harmful interference to radio communications. However, there is no guarantee that interference will not occur in a particular installation. If this equipment does cause harmful interference to radio or television reception, which can be determined by turning the equipment off and on, the user is encouraged to try to correct the interference by one or more of the following measures:

- » Reorient or relocate the receiving antenna.
- » Increase the separation between the equipment and receiver.
- » Connect the equipment into an outlet on a circuit different from that to which the receiver is connected
- » Consult the dealer or an experienced radio/TV technician for help.

ISED Canada compliance statement

This device contains licence-exempt transmitter(s)/receiver(s) that comply with Innovation, Science and Economic Development Canada's licence-exempt RSS(s). Operation is subject to the following two conditions:

1. This device may not cause interference.
2. This device must accept any interference, including interference that may cause undesired operation of the device.

Déclaration de conformité d'Innovation, Sciences et Développement économique Canada

L'émetteur/récepteur exempt de licence contenu dans le présent appareil est conforme aux CNR d'Innovation, Sciences et Développement économique Canada applicables aux appareils radio exempts de licence. L'exploitation est autorisée aux deux conditions suivantes:

1. L'appareil ne doit pas produire de brouillage.
2. L'appareil doit accepter tout brouillage radioélectrique subi, même si le brouillage est susceptible d'en compromettre le fonctionnement.

INTRODUCTION

The user interface of the Q Experience consists of three main components:

1. View
2. Sidebar
3. Application

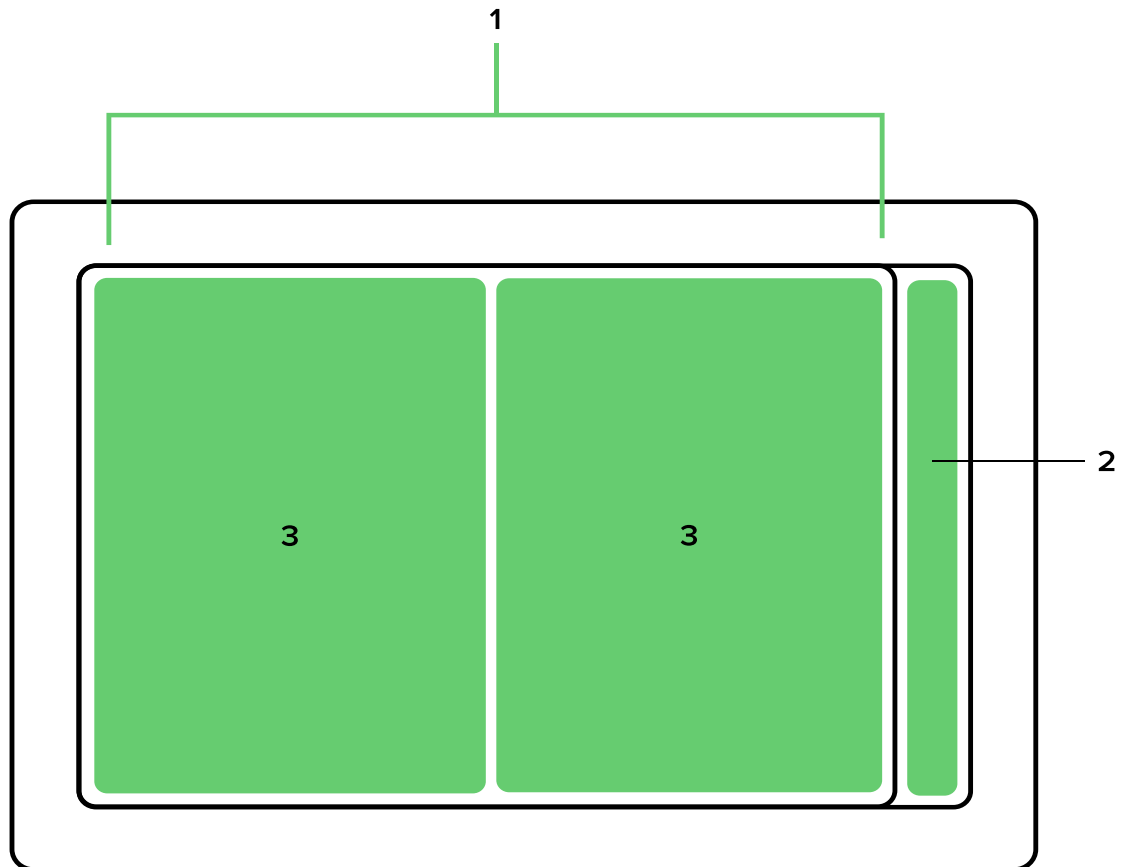

1. SIDEBAR

The Sidebar is the anchor of the Q Display's user interface. It is accessible from every view and provides instant access to all the essential functions and your favourite views. The Sidebar consists of:

1. Home button
2. Pinned views
3. Notification centre
4. System status area

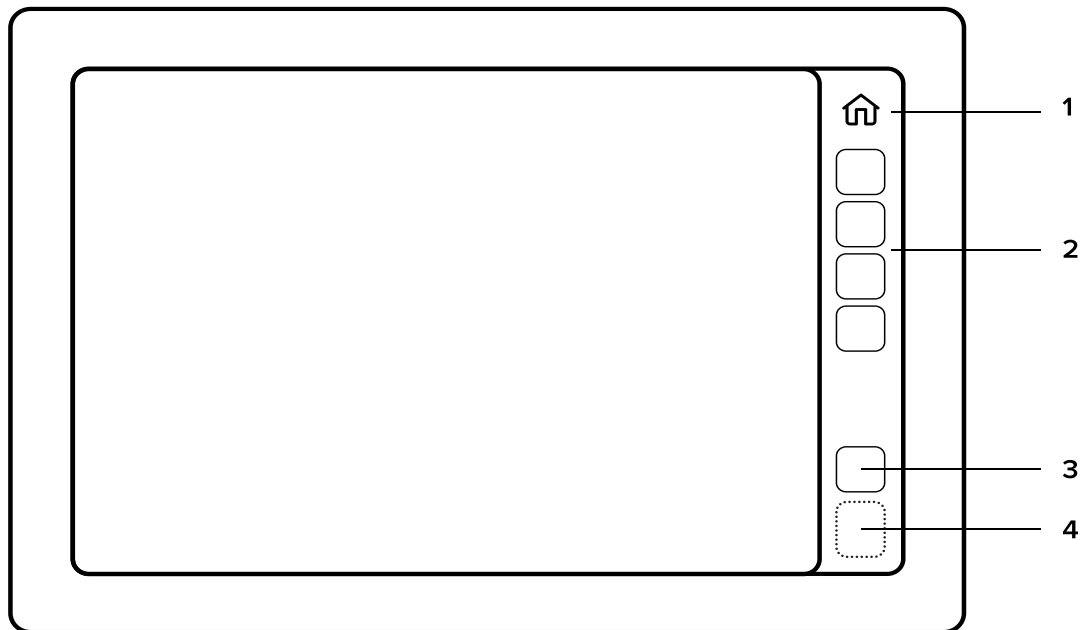

Home button

The Home button opens the Home menu. In the Home menu you will find all the available views and utilities – everything essential to control and adjust your device.



Pinned views

Below the Home button are the *Pinned* views. Pinned views is a customizable collection of views, that can be accessed directly from the sidebar.

Customize the Sidebar by pinning your favourite views to it:

1. Open the *Home menu*,
2. Open View properties by pressing the three dots (...) on the desired view
3. Select Pin to Sidebar.

To unpin a view, repeat the process above, but in the last step select Unpin from the sidebar instead. You can open the same contextual menu by long pressing the view icon in the Sidebar.

Notification centre and Notifications

Below the pinned views you will find the Notification centre. Here you can view and manage all the notifications that you have received.

Open the Notification centre from the Notification button (notification icon) in the Sidebar.



Notification icon

Every notification will first appear on the screen. All the notifications with normal or higher priority will be stored in the Notification centre until they are dismissed. Minor and highly contextual notifications, such as Bluetooth pairing success/fail, Wi-Fi connecting success/fail etc. will not be stored.

The Notification centre icon (notification icon) will indicate you of unread notifications. The highlight colour is based on the highest priority notification:

- » (Red icon): Alert
- » (Yellow icon): Warning
- » (White icon): Notification

System updates

Available system updates will appear as notifications (see the notification icon above). To activate the updates on your device, you must install the available system updates from the Notification centre. The installation might take a few minutes. After the installation is completed, the Q Display must be restarted.

System status area

Below the Notification centre is the System status area. Here you can see Wi-fi, SIM card, GPS positioning and Bluetooth status, plus a digital clock.

Status area icons (not active when gray)



Wi-fi



SIM card



GPS



Bluetooth

2. VIEW

View is an instance of one or more applications, shown on the screen at the same time. A view may consist of a single application (Fullscreen view) or two applications (Split view). Most of the application settings are view specific. For example, you may have two individual Map views with different settings for different scenarios.

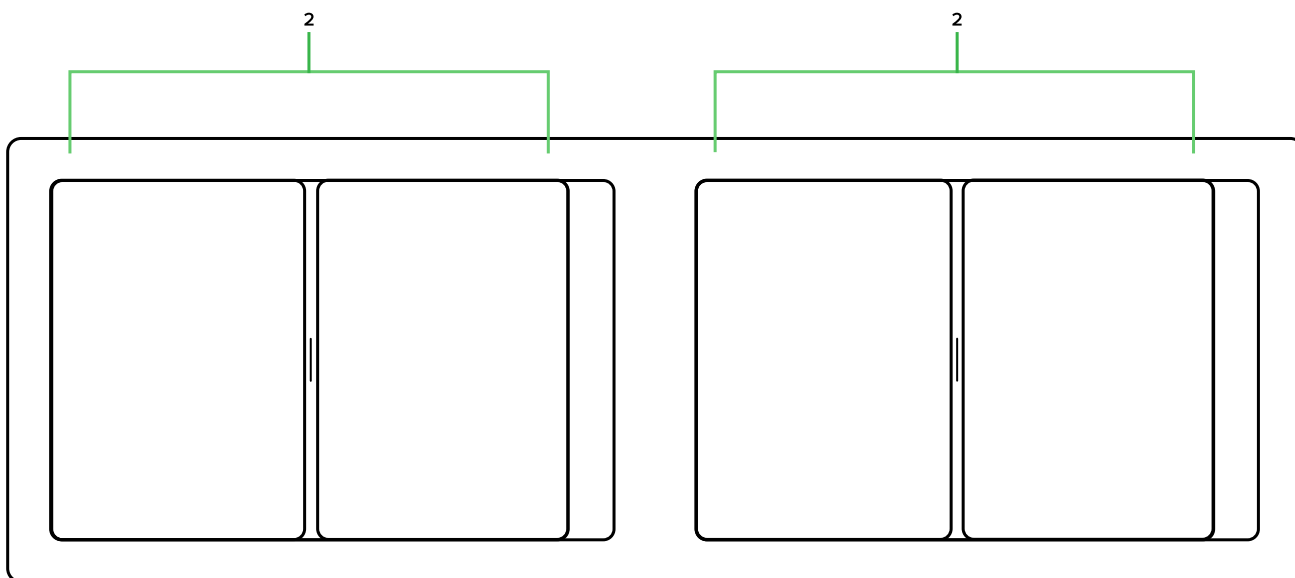

Two views in Q Display 210D

3. APPLICATION

Applications are assigned into a view. Map, Fishfinder, Radar etc. are applications.

 **The Application menu button** can always be found in the top right corner of every application. From the Application menu you can access all the application specific functions, such as Search for Map or Inputs for Music. Scroll the menu by dragging it up or down with your finger.

To close the Application menu, press the (X) button in the top right corner, or tap on the screen outside of the menu area.

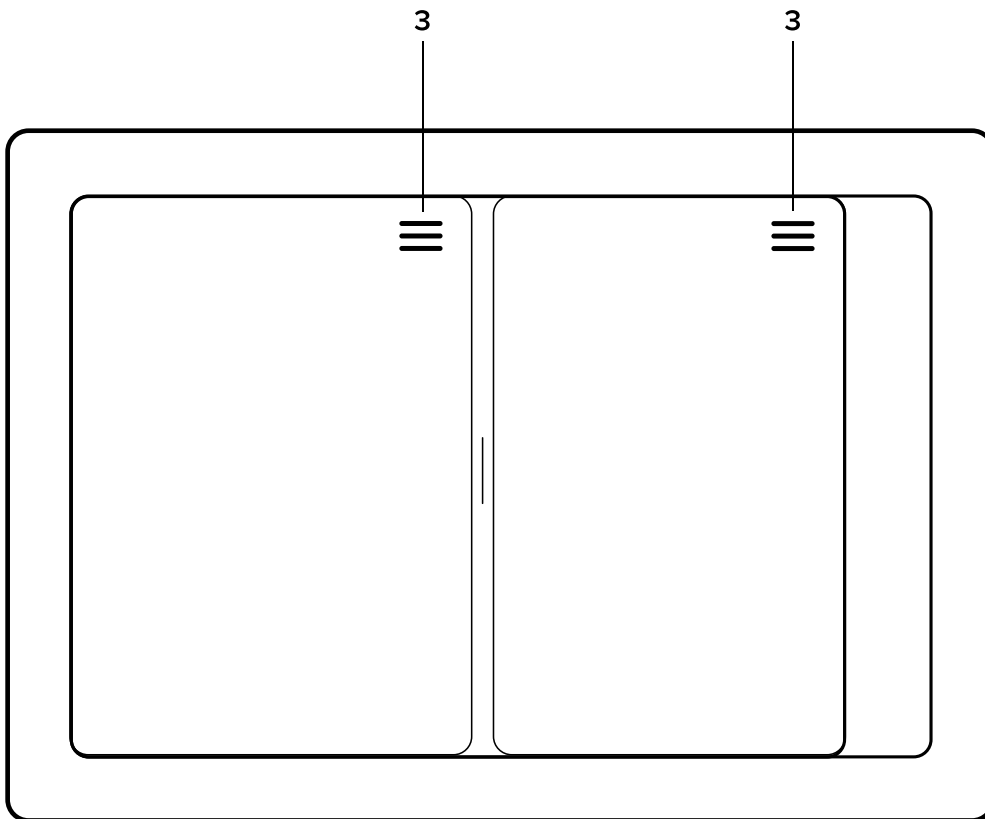

Application menu

See the application specific sections for more detailed instructions, starting from Chapter 5 Map.

4. HOME MENU

The Home menu is where you will find all the available views and utilities – everything essential to control and adjust your device.

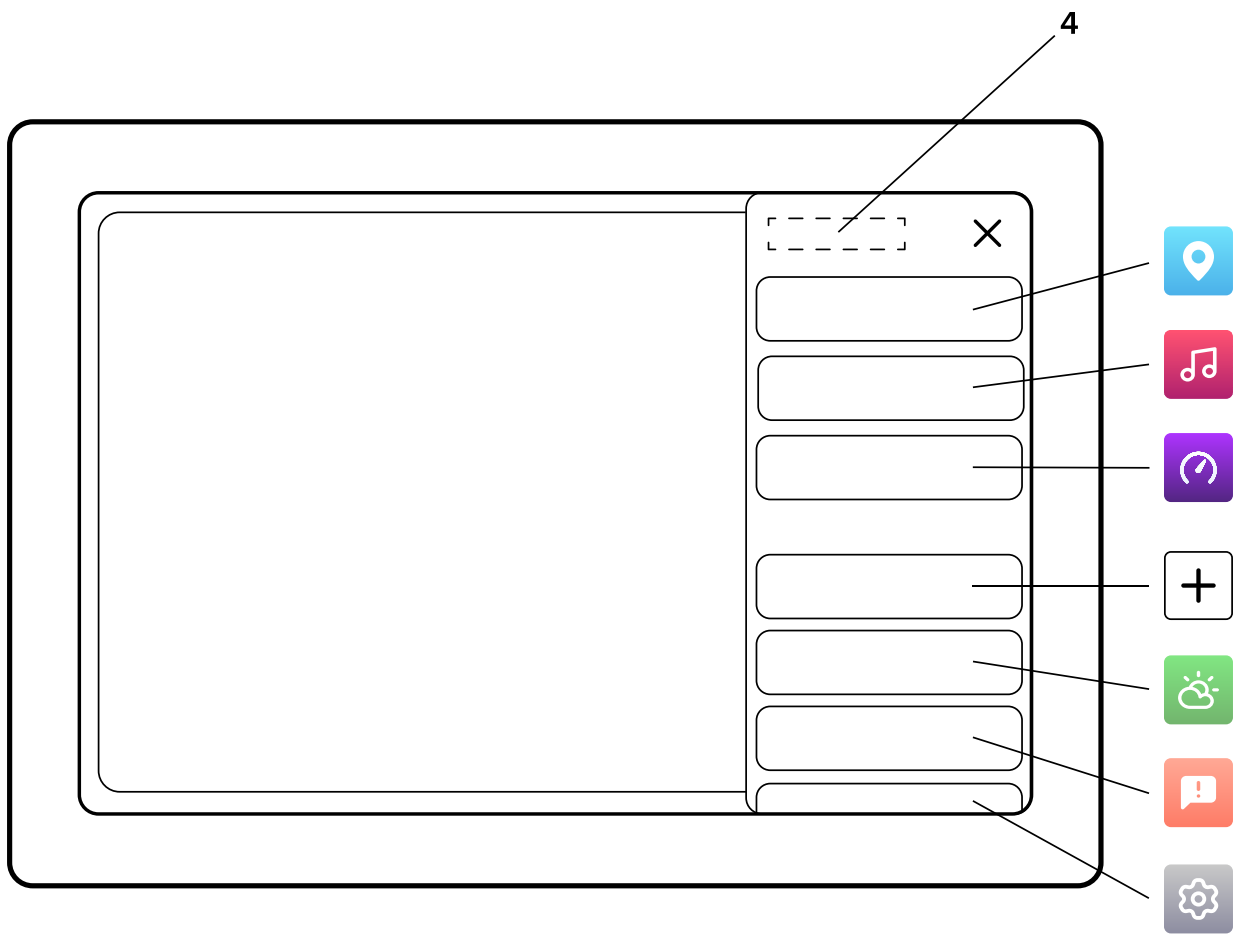

Open the Home menu using the Home button. Press (X) to close the menu. Scroll the menu by dragging it up or down with your finger.

4.1. Views

The topmost section of the home menu features all the default and custom views of the applications available to you. The available applications depend on your boat configuration and installed peripherals, such as speakers, radar or sonar/fishfinder.

Map and Dashboard applications will always be available, with respective full-screen views. To enable more applications for views, see Chapter 13.8 *Extra packages*.

Default and custom views

The first time you switch on your Q Display device and after a factory reset, you will start with a selection of default views. You are free to customize all of them and create your own custom views as you see fit.

To create a new view:

- » Open Home menu
- » Press on New view
- » Select the view template (see list below)
- » Assign desired applications to the viewports
- » Press “checkmark” when done to save the view
- » Activate, pin and edit your new view from the Home menu.

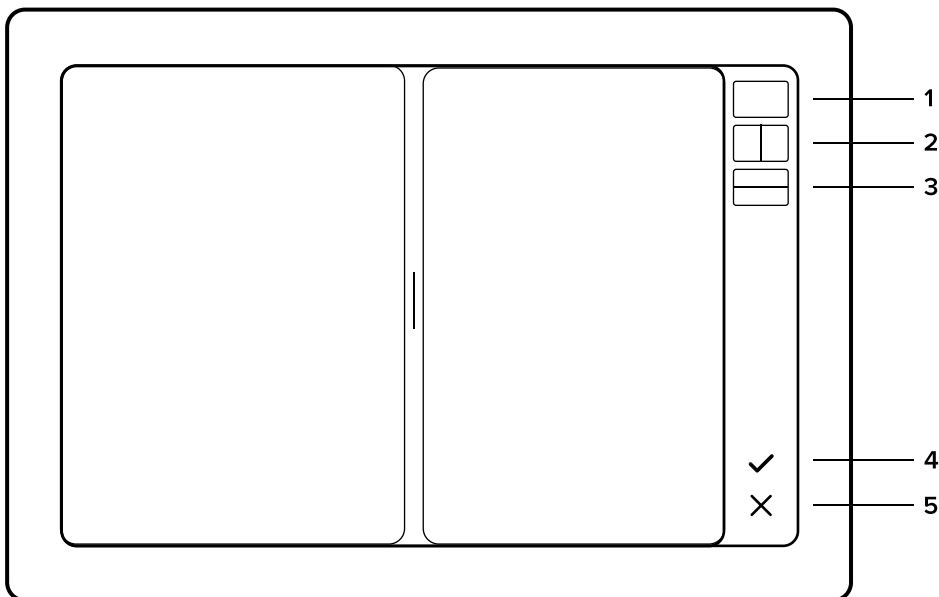

1. Fullscreen view
2. Vertical split view
3. Horizontal split view
4. Save and exit
5. Cancel and exit

4.1.1. Manage views

If you would like to pin, launch or remove default or custom views:

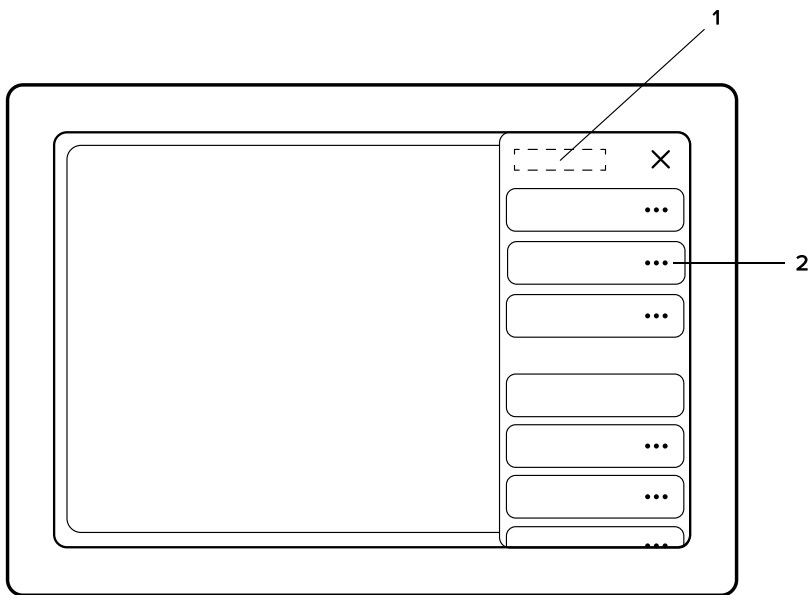

1. Home
2. Open View properties by pressing the three dots (...) on the desired view

View properties

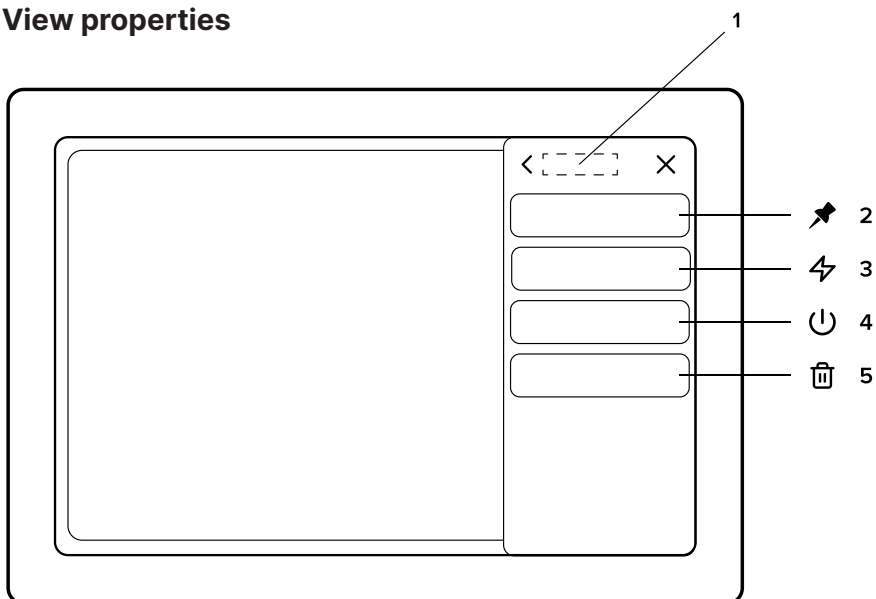

1. Application title
2. Pin to Sidebar / Unpin from Sidebar
3. Launch
4. Launch at startup
5. Remove from views

4.1.2 Reset views

If at some point you would like to go back to the factory set default views:

- » Open Home menu
- » Select Settings
- » Select System reset

NOTE, that this action is irreversible, and all your data and custom views will be removed.

4.1.3 Split view

When the view is split into two, it is called a “split view”. When you are using a split view, you can adjust the split ratio anytime, by dragging the handle between the applications. The handle will snap to the closest split point when released. The default split points are:

75/25

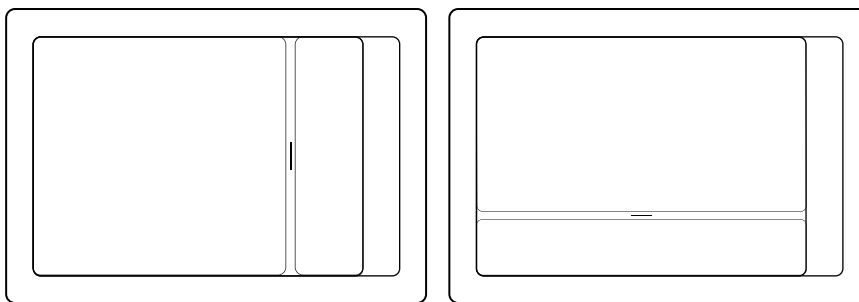

50/50

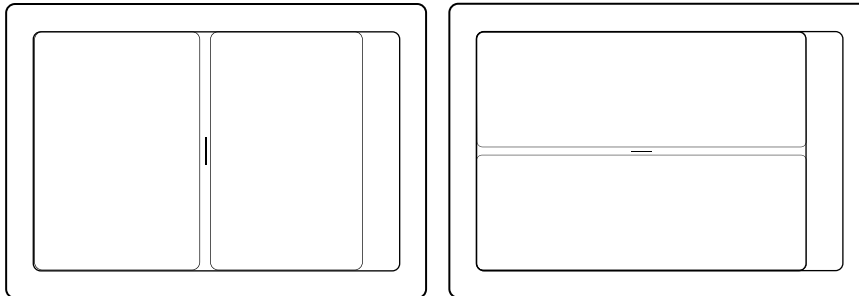

25/75

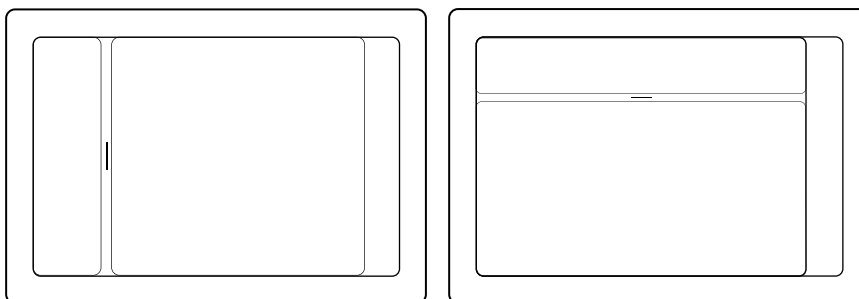

4.2 Utilities

Under Utilities, you will find all the utility applications, like Settings, Weather, and Info. Utility applications are opened on top of your current view, instead of in a dedicated view. Press the close button (X) in the top right corner, to close the utility application, and return to your main view. Utility applications consist of a tab list on the left and a content area on the right.

Utility applications cannot be assigned into custom views.

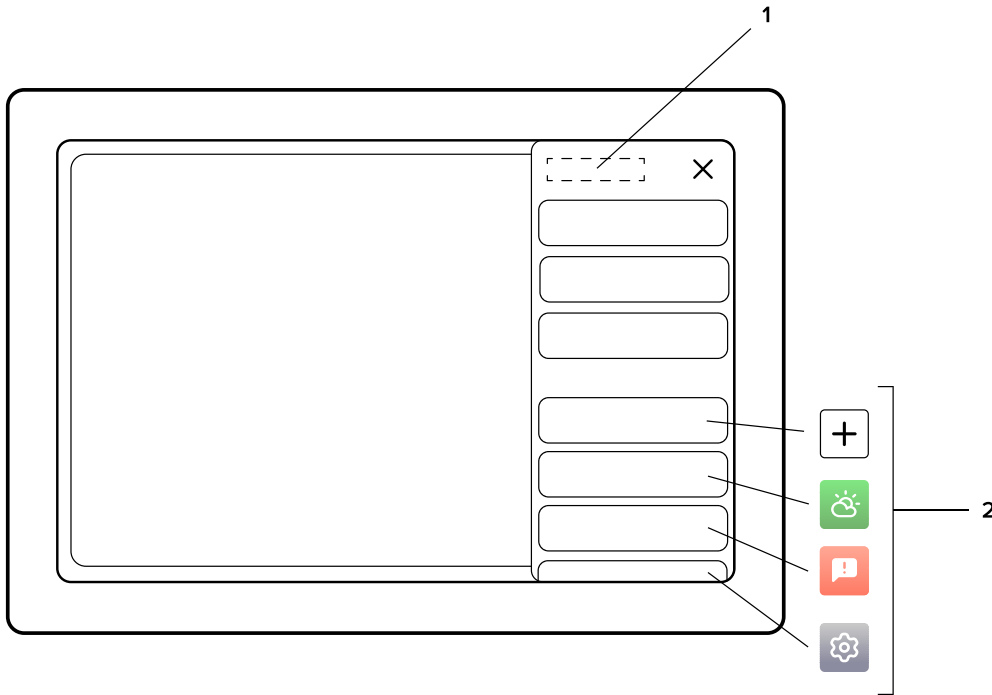

1. Home
2. Utilities

5. MAP



Here you can navigate, explore, and save places and routes

Launch the Map view by opening the Home menu and selecting Map. The Map application consists of the Chart area, Application controls in the top right corner and optional Compact dashboard in the top left corner.

Chart/Map app

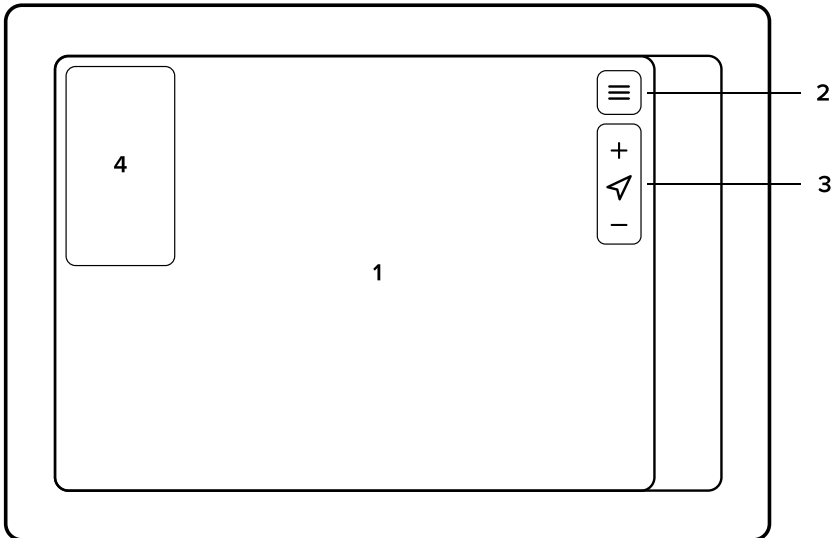

1. Chart / Map area
2. Map menu
3. Map control
 - » (+) increase zoom button
 - » Centre map button
 - » (-) decrease zoom button
4. Compact dashboard

5.1 Map basics

5.1.1 Panning

Pan the Map by dragging it in the desired direction with your finger.

5.1.2 Centering

Center the view back to your position by pressing the *center map button* in Map controls.

5.1.3 Zooming

Zoom in by spreading two fingertips on the screen, pinch to zoom out. Alternatively use the buttons in Map controls.

Zoom in:

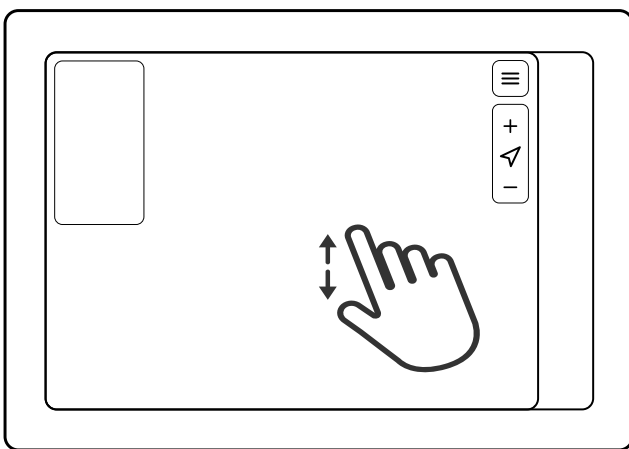

Zoom out:

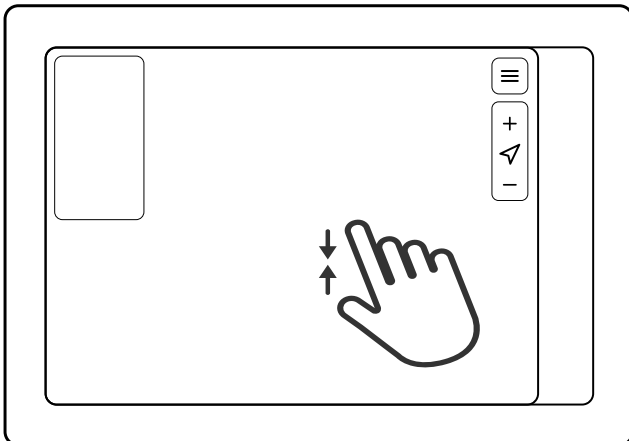

5.1.4 Measure distance

Measure distance by placing two fingertips on the screen at the same time, one on the start point and other at the end of the distance you wish to measure.

5.1.5 View location information

Long press on the map area with one fingertip to view location information and open the Location menu. See the next section Location properties for more information.

5.2 Location properties

The *Location properties* is where you will see the coordinates and distance information for the selected position, as well as access location specific functions.

Open *Location properties* by long pressing on a desired location on the chart with your finger. You can also open the location properties by choosing a location from My places, found from the map's application menu.

The Location properties include:

5.2.1 Location information

Location information displays the coordinates and your current distance, time and needed fuel to the location.



5.2.2 Set as destination

Set the location/place as destination and start navigating.



5.2.3 Save to My Places / Edit place

Save the location to My Places by pressing the icon. Once a place has been added to My places, it can be edited by the edit icon. You will find My places in the map's application menu.



5.2.4 What's here?

Inspect nearby marine markers, chart notation and points of interest.



5.2.5 Move the position

Adjust the location/place position.

- » Press on the Move position to activate move mode.
- » Pan the chart under the Marker to the desired location.
- » Press on Move position again to end move mode and pin the Marker to the new position.



5.2.6 Center to

Center the chart to the selected location/place.

5.3 Navigation / Set a destination

The Q Experience provides robust auto-routing and navigation capabilities and is compatible with Navionics+ and Platinum+ marine charts. To start navigating, just set the destination or select an existing route to use for navigating. NOTE: An active Navionics+ subscription is required to use Autoroute with Navionics charts.

To set a destination, do one of the below:

Search for the place to use as destination

- » Open Search in the Map's application menu.
- » Type in the place you want to find.
- » Select the corresponding option from the search results.
- » Select Set as destination in the Location properties menu.

Select the destination on the chart

- » Long press on the location where you want to go on chart.
- » Select Set as destination in the Location properties menu.

Select destination from My Places

- » Open My Places in the Map's application menu.
- » Select place you wish to go to.
- » Select Set as destination in the Location properties menu.

To use an existing route, do the following:

- » Open My Routes in the Map's application menu.
- » Select the route you wish to use for navigation.
- » Select Start navigation in the Route properties menu.

When navigating existing routes, the route direction and destination's end are determined automatically, based on which way you are currently heading, and how far you are from route end points.

Once you have set the destination or selected a route, the navigation route will remain visible until the navigation is stopped by the user – even if the Q display is rebooted.

To end or pause navigation, open the Map's application menu and press on the stop or pause. If you want to change the direction of the navigation on a route press the Change direction icon in the Map's application menu.

5.4 Map's application menu

The Map's application menu includes all the essential functions, to utilize and adjust the Map application. Open the Map's application menu by pressing the application menu button (chapter 3) in the application's top right corner.

Press (X) to close the menu.

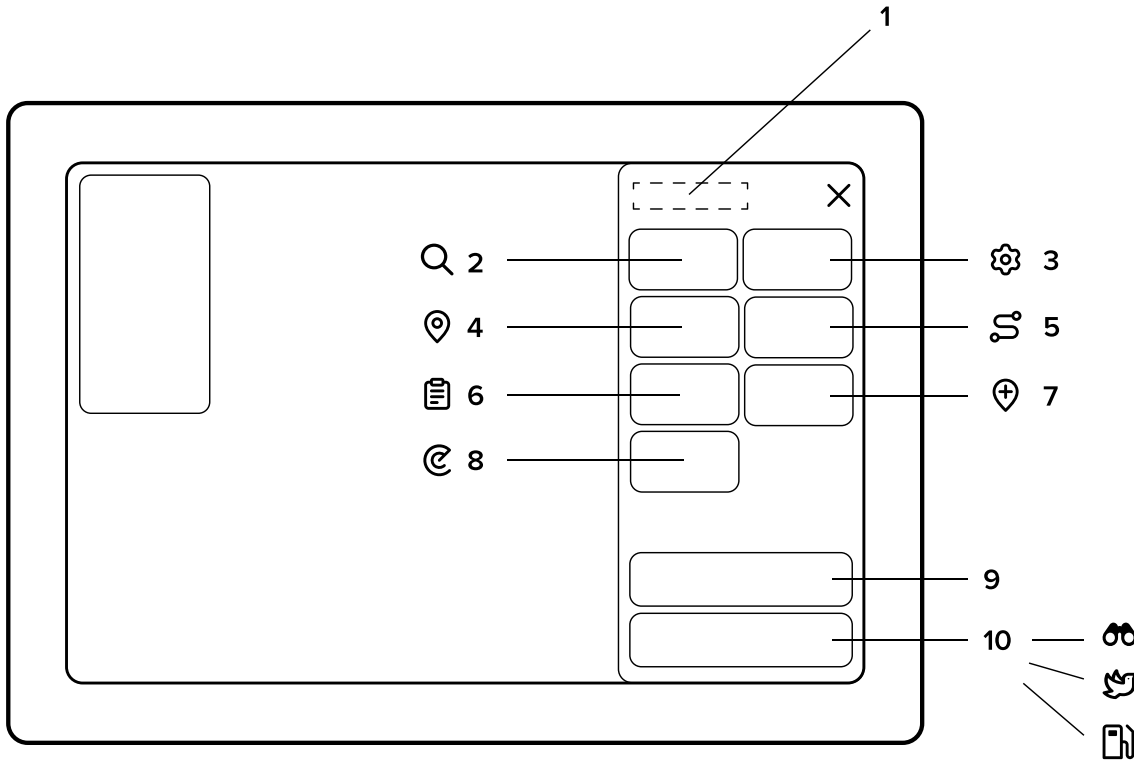

1. Map menu

2. Search

The Search function allows you to explore and find places.

3. Chart settings

Find detailed settings to use for navigation in the Chart settings. Read more about chart settings below in Chapter 5.5 Chart settings.

4. My places

View and manage all your saved places.

Select an existing location to view and manage. Select (+) New place to create a new place on your current location – you can adjust the location while creating a new place, for more.

5. My routes

View and manage all your saved routes.

Select (+) New route to start creating a new route. Select an existing route to open Route properties and view route information.

6. Log

View and manage previous trips and trip information.

7. Place here

Place here instantly creates a place on your current location. By pressing the place here button the current location is instantly saved to My places.

This is especially useful when you are required to instantly mark a location on the go, like when spotting a rock or in man overboard (MOB) scenarios.

8. Radar settings

If you have a radar installed in your boat, you can overlay the radar picture on the chart. This makes reading and understanding the radar easy, even for first time users. In Radar settings you can set the transparency of the overlay.

Widgets

Widgets are set to **Off** by default. Switch them on in the Map's application menu.

9. Compact dashboard widget settings

Here you can control the compact dashboard widget that is displayed on your chart view. Dashboard settings like engine, resources, environment, trip meters, and audio volume can quickly be toggled on or off.

Open the compact dashboard settings at the bottom of the tab list in the Map's application menu.

10. Utility menu

The Utility menu includes three different features, which can all be used by long pressing them.

To add the utility menu to your chart view, select utility menu at the bottom of the tab list in the Map's application menu. You can toggle the chart utilities on or off.

Utility features



See ahead

By long pressing the binoculars icon, your map will pan forward to show you what is up ahead.



Bird-eye-view

By long pressing the bird icon, your map will pan to a bird-eye-view.



Fuel range display

By long pressing the fuel tank icon you will see an estimate on your range depending on your fuel level.

NOTE: for this function to work, the **fuel tank capacity** needs to be set in the Boat settings, see Chapter 13.8.

5.5 Chart settings

Chart settings provide various settings for adjusting the chart view to your preferences.



Open Chart settings in the Map's application menu, by pressing the Chart settings icon. All these settings are view specific – so changing them only affects the currently active view. Chart settings include:

General

Chart orientation

Chart orientation sets the chart orientation to North-up or Course-up. With Course up your course direction continuously points upwards, instead of rotating.

Course vector

Course vector is a projected line that indicates your heading. Can be toggled on or off.

Show trail

Show trail displays the route you have sailed with a line on the map. Can be toggled on or off.

Autocentre

Autocentre automatically recentres the map to your position after a few seconds of inactivity. Can be toggled on or off.

Autozoom speed limit

Choose the speed limit for autozoom. Autozoom zooms in the chart when driving slower than the set speed limit. Set the speed limit or turn off by setting to zero.

Low speed zoom level

Choose the zoom level for a low boat speed. This is the zoom level used when Autozoom is activated (see above).

Chart layers

Easy view™

EasyView™ is a Navionics exclusive feature, that makes the chart easier to read. It increases the Chart's text and marker size and hides irrelevant minor notation. Can be toggled on or off.

SonarChart™

SonarChart™ is a Navionics exclusive feature that provides much more detailed depth contours, with adjustable line density. The shading option allows you to see the depth contours in 3D like shapes. Can be set to preferred density or turned off.

2D shading

This feature adds a 2D shading to your chart view to better indicate the depths of water. Can be toggled on or off.

Community edits

Community edits displays possible edits or notions added by other boaters. Can be toggled on or off.

Chart details

Chart details dictates if the chart shows standard or advanced markings. Can be set to preferred setting.

Satellite overlay

Satellite overlay allows you to use a satellite image overlaid on the chart. Satellite options include modes for Land, Land and shallow, and Land and sea. Can be set to preferred setting or turned off.

Satellite overlay opacity

Choose a percentage of opacity for the satellite view. The closer to 100 % you set the satellite opacity, the more visible the satellite image will be.

Depths and altitudes

Default zoom level

Set the default level of zoom in your chart view. This is the zoom level your chart will have on start up and return to when Autozoom is activated. You can manually return to the default zoom level by double tapping the Centre map button. Can be set to preferred value.

Safe water depth

Set the safe water depth according to your boat's draught. This will show depths above safe water depth as white on the chart. Can be set to preferred value or turned off.

Shallow water depth

Set the shallow water depth according to your preferences and your boat's draught. The set depth will mark depths below shallow water depth with a red grid. Can be set to preferred value or turned off.

Spot soundings

Set the upper depth limit for spot soundings. Can be set to preferred value or turned off.
NOTE: Chart details must be set to Advanced for spot soundings to be visible.

Depth contours

Set the upper depth limit for depth contours on the chart. Can be set to preferred value or turned off.

Minimum fishing range

Set the lower limit for fishing range. This feature marks waters between Minimum fishing range and Maximum fishing range as white. Can be set to preferred value or turned off.

Maximum fishing range

Set the upper limit for fishing range. This feature marks waters between Minimum fishing range and Maximum fishing range as white. Can be set to preferred value or turned off.

Reset chart settings

Resets the chart settings to the defaults. Note, that this will only reset the settings for the active chart view.

5.6 Location and route properties

Location properties

The location properties can be opened in My places or by long pressing a point on the chart. You can read more about location properties in the Chapter 5.2 *Location properties*.

Location properties include Place information, Edit place, Set as destination, What's here?, Move position, Center to, and Remove.



5.6.1 Set as destination

Set your saved place as the destination and calculate a route to your saved place.



5.6.2 Edit place

Edit your saved place, includes Name, Color, Notify on approach, and Change position.

Name is the name that is displayed on the chart

Color is the color of the marker on the chart.

Notify on approach lets you set an alert when you are approaching the place. Can be set to preferred distance or turned off.

Change position change the location of your saved place.



5.6.3 Plan route from here

Start planning a route from the selected location.



5.6.4 What's here?

See what is near your saved place, such as rocks, obstructions, or recommended tracks.



5.6.5 Center to

Center map to the saved location.



5.6.6 Remove

Long press to remove the location from *My places*.

5.7 Route properties

Open Route properties by selecting a route from My Routes. It can be found in the Map's application menu.

Route properties include:



5.7.1 New route

Here you can add a new route to be saved in My routes. You can name the route and choose a color for the route on the chart. Make sure to press the checkmark Save to save the route to My routes. Once the route is saved you can set it as a destination.



5.7.2 Route information

You can see the route information by selecting a route in My routes. Route information displays the length, time and total fuel consumption for the route.



5.7.3 Start navigation

Set the selected route as the active navigation route. Route direction and destination end is determined automatically, based on which way you are currently heading, and how far you are from route end points. The direction can be changed by toggling Change direction in the Map's application menu.



5.7.4 Show on chart/Hide from chart

Select if you want the route to show, or not to show, on the chart view.



5.7.5 Edit route

Edit route launches the route editor, which allows you to edit the route points, route color, and route name.



5.7.6 Center to

Center to function centres the route and zooms out so that the entire route will become visible in the application.



5.7.7 Remove route

Remove the route from My Routes.

6. DASHBOARD



To show Dashboard data, the Q Display offers two distinct solutions:

- » *Dashboard application*
- » *Compact dashboard widget*, a widget that can be seen on the left side of a chart view.

This chapter covers the Dashboard application. For information about the *Compact dashboard widget*, see Chapter 7.

Launch the Dashboard application by opening the Home menu and selecting Dashboard. The Dashboard application consist of the Display area in the centre and Application controls on the top.

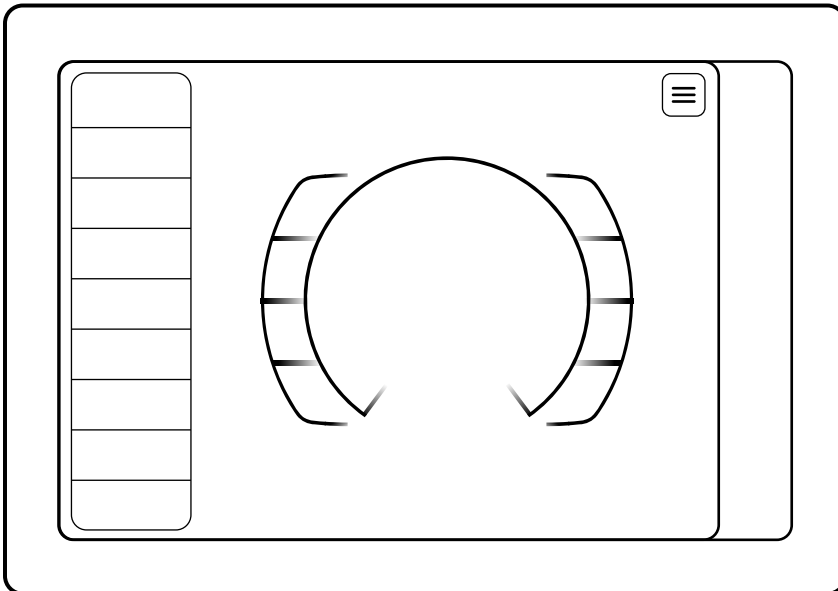

6.1 Dashboard app

The values on the main dashboard are fixed to RPM, Speed, Compass, Fuel level, Trim level, and Consumption. To get more information the dashboard can be complemented with widgets to the left of the gauges.

To re-order the application controls on dashboard, press and hold on an application control, wait for the re-order mode to activate (changes to blue color) and then simply drag and drop the selected instrument into the desired space.

Notice that the available instruments depend on the activated packages, supported by your boat configuration and peripherals. To activate more Application packages, see Chapter 13.8.5 *Extra packages*.

6.2 Dashboard Settings

Open Dashboard settings by pressing the *application menu button* in the application's top right corner.

The Dashboard menu features visibility toggles for various application controls that can be shown in the Dashboard view. Enable the toggle on the feature to show it, disable to hide.

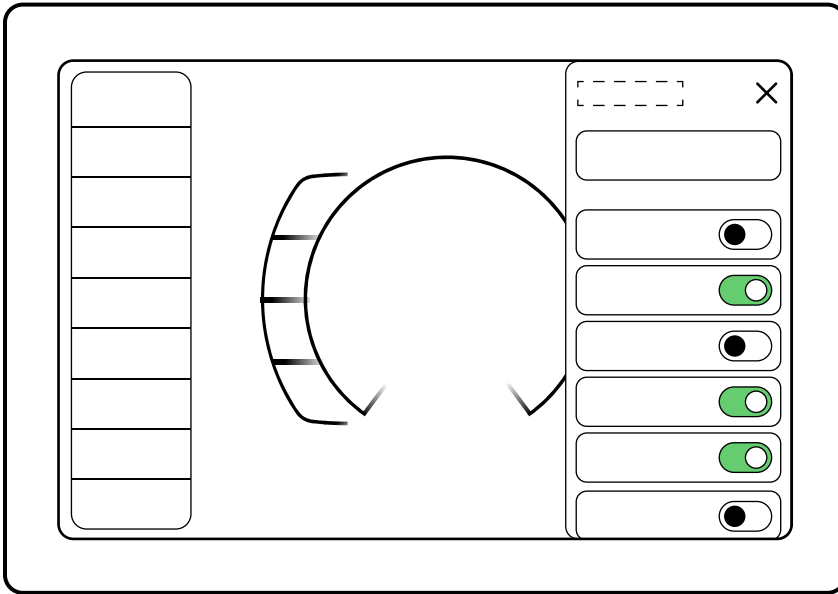

Dashboard's application menu

All the features that can be found from the Dashboard menu are following:

- » Engine
- » Resources
- » Environment
- » Trip meters
- » Settings
- » Radar controls

Engine

RPM

Displays the level of RPM.

Engine temperature

Displays the engine temperature.

Trim level

Displays the current trim angle.

Engine hours

Displays how many hours the engine has been in use.

Alternator Voltage

Displays the alternator voltage. **NOTE:** Alternator voltage is not Battery voltage.

Trolling

Adjust the trolling speed by fine-tuning the RPMs.

Throttle level

Displays the amount of throttle in % (if supported by the propulsion system).

Throttle state

Displays the throttle state: Drive, Neutral or Reverse (if supported by the propulsion system).

Output power (Only for electric propulsion)

Displays the engine's power output.

Engine voltage (Only for electric propulsion)

Displays the engine's voltage.

Resources

Consumption

Displays the fuel consumption in *litres per hour*.

Economy

Displays the fuel consumption in *litres per kilometre*.

Fuel level

Displays the fuel level of the fuel tank(s).

Battery voltage

Displays the battery voltage.

AUX battery voltage

Displays the voltage of the auxiliary battery.

Battery temp (Only for electric propulsion)

Displays the temperature of the battery.

Battery SOC (Only for electric propulsion)

Displays the battery's State of Charge (SOC).

Environment

Speed

Displays the speed of the boat.

Speed conversion

Displays the speed in Km/h, mph and Kn.

Position

Displays your position in coordinates.

COG

Displays the *Course over Ground* (COG), which is the course your boat is travelling (may differ from heading due to wind or stream).

Heading (Requires additional sensor)

Displays where your boat is pointing.

Compass

Displays the compass course.

Depth (Requires additional sensor)

Displays the depth of water.

Water temp (Requires additional sensor)

Displays the water temperature.

Target direction

Displays the direction of the destination.

Wind (Requires additional sensor)

Displays the wind direction.

Range estimation

Displays the estimated range based on fuel or battery charge.

Trip meters

Current trip

Displays information on your current trip.

User trip A

Trip meter for user A

User trip B

Trip meter for user B.

To the destination

Estimates the consumption, duration, and distance to your destination.

Settings

Audio volume

Adjust volume of your media.

Radar controls

Radar range

Adjust the range of the radar.

7. COMPACT DASHBOARD WIDGET

This chapter covers the Compact dashboard widget. For information about the *Dashboard application*, see Chapter 6 *Dashboard Application*.

The *Compact dashboard widget* is the dashboard widget, that can be found in selected applications. Currently we support Compact dashboard in Map, Fishfinder and Radar.

You can manage the information displayed on the compact dashboard widget by navigating to the application menu (for example Map's application menu) and selecting Dashboard. Use toggle bars to add or remove instruments.

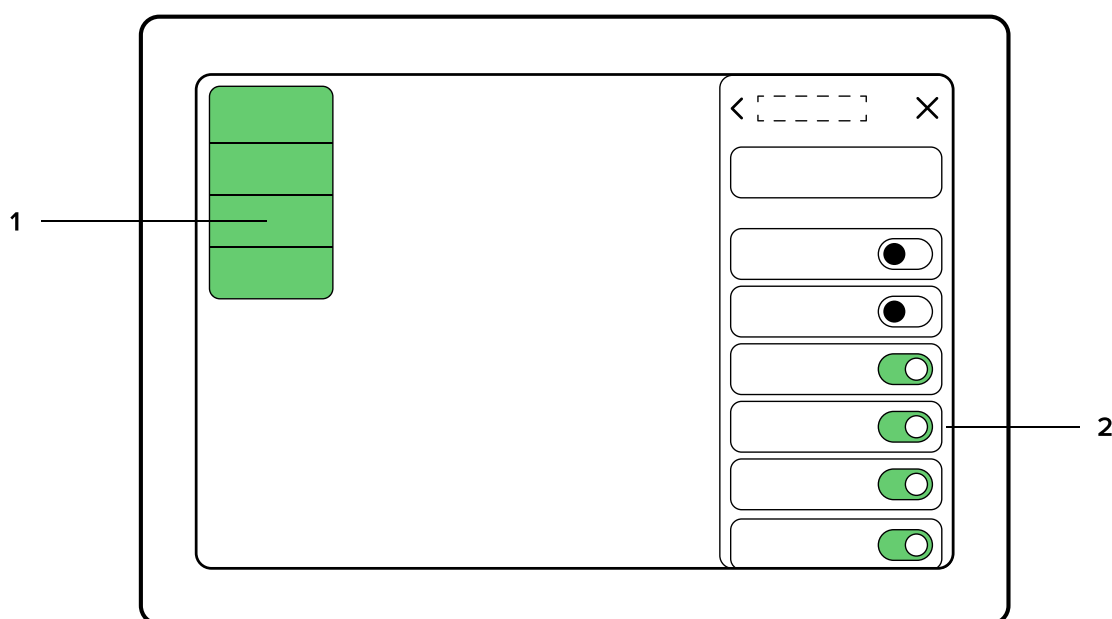

1. Compact dashboard

The Compact dashboard panel will always be in the top left corner of the Application viewport.

To re-order the application controls in the Compact dashboard widget, press and hold on an instrument, wait for the re-order mode to activate, and then simply drag and drop the selected instrument into the desired space.

2. Compact dashboard activations in the application menu button

For contents, see Chapter 6 Dashboard under dashboard's application menu.

Notice that the available controls depend on the activated packages, supported by your boat configuration and peripherals. To activate more Application packages, see Chapter 13.8 *Extra packages*.

8. FISHFINDER



The Q Experience is compatible with Raymarine's CP100 and Airmar IC-TM90M Fishfinders. For more information on their qualities and how to use them, visit www.raymarine.com or www.airmar.com.

Launch the Fishfinder application by opening the Home menu and selecting Fishfinder. The Fishfinder application consists of a Display area in the centre, Fishfinder controls in the top right and optional Compact dashboard on the top left.

Fishfinder menu

Open Fishfinder menu by pressing the application menu button in the application's top right corner. The menu consists of the following settings:

- » Dashboard
- » CP-100 Fishfinder
- » Airmar IC-TM90M

Dashboard

Compact dashboard widget, see chapter 7 *Compact dashboard widget*.

CP-100 Fishfinder

Sonar channel

Choose between CHIRP or DownVision sonar image.

Gain mode

Set the Fishfinder's sensitivity. Can be set to *Automatic* or *Manual*.

Smoothing mode

Smooths the sonar image to get rid of unnecessary roughness. Can be set to *Automatic* or *Manual*.

Filter mode

Removes small disturbances in the water. Can be set to *Automatic* or *Manual*.

Depth levels

Choose the preferred amount of depth levels shown. Can be set to preferred value between 1 and 10, *Automatic*, and turned off.

Seabed enhancing

Highlights the seabed. Can be toggled on or off.

Depth lines

Shows the *depth levels* as lines across the application area. Can be toggled on or off.

Visible horizon

Shows an artificial horizon on the top of the Fishfinder graphics. Can be toggled on or off.

Automatic scrolling

Automatically scrolls back to the front after a couple of seconds when sonar image has been scrolled backwards. Can be toggled on or off.

Scrolling speed

Set the preferred value for the scrolling speed in the Fishfinder application. Can be set to a value between 1 and 8.

CHIRP color scheme

Set the preferred color scheme for the CHIRP sonar image. Can be set to *Default*, *Sand* or *Greyscale*.

DownVision color scheme

Set the preferred color scheme for the DownVision sonar image. Can be set to *Default*, *Sand* or *Greyscale*.

Airmar IC-TM90M

Automatic noise rejection

Noise rejection removes small disturbances in the water. Can be set to *Automatic* or *Manual*.

Automatic sensitivity

Set the sensitivity for the Fishfinder. Can be set to *Automatic* or *Manual*.

Automatic range

Automatic range sets the depth range shown in the Fishfinder app. Can be set to *Automatic* or *Manual*.

Depth levels

Choose the preferred amount of depth levels shown. Can be set to preferred value between 1 and 10, *Automatic*, and turned off.

Color scheme

Set the preferred color scheme. Can be set to *Default*, *Sand*, or *Greyscale*.

Seabed enhancing

Highlights the seabed. Can be toggled on or off.

Depth lines

Shows the depth levels as lines across the application area. Can be toggled on or off.

Automatic scrolling

Automatically scrolls back to the front after a couple of seconds when sonar image has been scrolled backwards. Can be toggled on or off.

Visible horizon

Shows an artificial horizon on the top of the Fishfinder graphics. Can be toggled on or off.

Scrolling speed

Set the preferred value for the scrolling speed in the Fishfinder application. Can be set to a value between 1 and 8.

9. RADAR



The Q Experience is compatible with Raymarine's Quantum Q24 Chirp Radar. For more information on their qualities, visit www.raymarine.com.

Launch the Radar application by opening the Home menu and selecting Radar. The Radar application consists of a Display area in the centre, Radar controls in the top right corner and optional Compact dashboard on the top left.

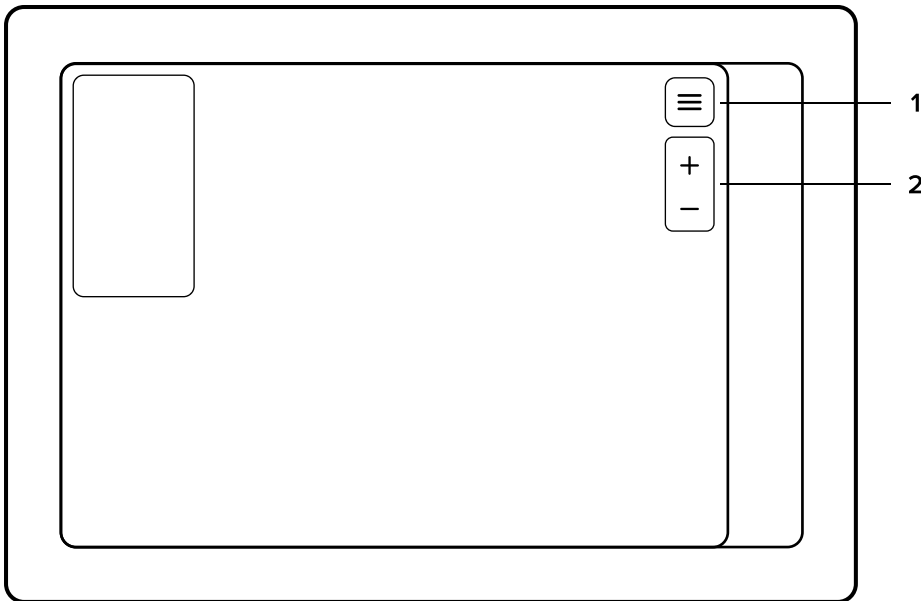

1. Radar menu

Open the Radar's application menu by pressing the application menu button in the application's top right corner. The Radar's application menu consists of the following:

- » Radar display
- » Radar control

Radar display

Heading mode

Heading mode sets the chart orientation to North-up or Course-up. With Course-up your course direction continuously points upwards, instead of rotating.

Reflection color

Reflection color dictates what color the radar will show objects as.

Radar control

Power

Turn the radar on or off.

Preset

In preset you can set pre-made setting combinations depending on your location. This feature is useful for first time users, or for a quick setup.

Increase/Decrease range

Increases or decreases the preferred range of the radar.

Gain

Toggle the Gain to automatic or manual. Gain is the sensitivity of the radar, used to minimize interference. If set to manual, the value can be fixed to a preferred level. *Color gain*.

Toggle the Color gain to automatic or manual. If set so manual, the value can be fixed to a preferred level.

Sea clutter

Toggle Sea clutter to automatic or manual. Sea clutter is used to minimize interference caused by rough seas. If set to manual, the value can be fixed to a preferred value.

Rain clutter

Toggle Rain clutter to automatic or manual. Rain clutter is used to reduce interference used by rain. If set to manual, the value can be fixed to a fixed level.

Radar offset

Fine tune the setup of the radar to compensate for offsets in the mounting, by rotating the radar image.

NOTE: Changing the adjustments in Radar settings will change them for every instance of the application, note only for the specific view. This is because the adjustment changes the actual physical behaviour of the device.

2. Radar zoom controls

Zoom in, or out, on the radar image.

10. MUSIC



The Music application serves as the central entertainment controller of your boat's audio setup. From here you can listen to radio and stream media from external devices via Bluetooth or AUX cable. In the equalizer you can fine-tune the audio profile to match your listening preferences.

Launch the Music application by opening the Home menu and selecting Music. The Music application consists of a Player area in the centre and Music application controls in the top right.

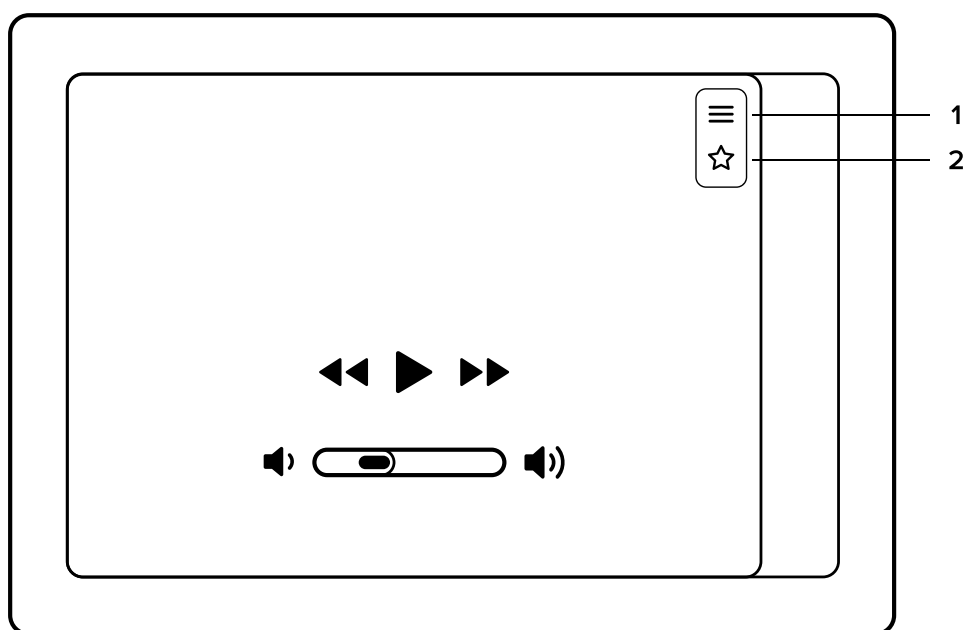

1. Music menu button
2. Favourite radio settings OR bluetooth settings

Music player area

The player info field shows contextual info related to the active radio station or Bluetooth stream etc.

The player controls feature:

- » Previous
- » Play / Pause
- » Next
- » Decrease volume
- » Increase volume

Music menu

Open the Music application's menu by pressing the application menu button in the application's top right corner.

The music menu provides access to:

- » Radio
- » Bluetooth input
- » AUX input
- » Equalizer

Radio input and Favourites

To listen to the radio, open the Music menu and select Radio in the input list. By default, Music application will start with the Radio input selected.

When listening to the radio, press the "previous" and "next" buttons to auto-scan for radio stations. Press the "pause" button to temporarily mute the radio.

For information about switching between FM and DAB modes, see *Audio settings* in Chapter 13.10.

When listening to the Radio, it is possible to save a station to your Favourites for quick access. To save the current station to Favourites, press the Favourites button to open the Favourites menu. In the Favourites menu select the option *Add to favourites*. Once a certain frequency has been saved as a favourite, it will remain in the list until its "Favourite" status has been removed.

To remove a station from Favourites, open the Favourites menu, and toggle the icon next to the station's name.

Bluetooth input

To listen to media via Bluetooth, open the Music menu and select Bluetooth from the input list. If you have a device connected and ready to play, press play on either the connected device or Music application.

You can control music either from the Q Display or from the connected device.

To connect a new device, open the Bluetooth application in the Music application menu, press on and then choose Add new device. If the device has been previously connected, choose the device from the My devices list. From devices list connect to a desired device.

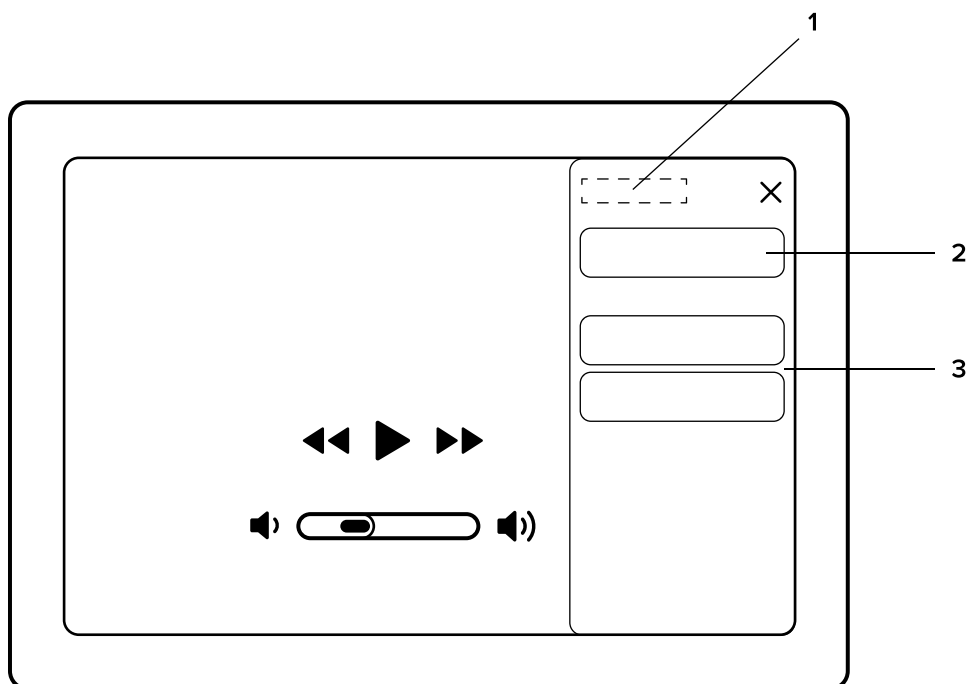

1. Devices
2. Add new device
3. Connected devices

Aux input

To use AUX input, open the Music menu and select AUX in from the input list. Connect the external device to Q Display via AUX cable and start playing music or other media from the external device. Using AUX, audio volume is the only possible adjustment you can do on the Q Display. Notice that Q Display's volume is not linked to your external device volume, so adjusting the external device's volume output might be necessary.

Equalizer

Adjust the individual frequencies within an audio source with the Equalizer. The level of the frequencies are adjusted by the sliders. Reset all frequencies by pressing Reset on the right side of the toggle bars.

You find the equalizer in the Music menu.

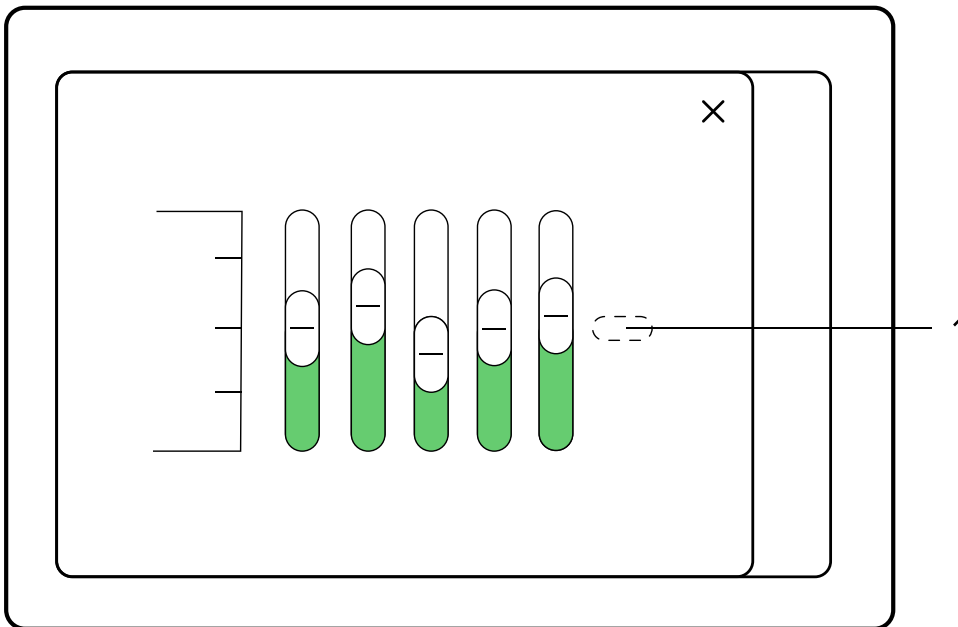

1. Reset

11. WEATHER



The Weather App provides real time weather forecasts for the next 24 hours, based on AccuWeather's weather data.

Launch the Weather application by opening the Home menu and selecting Weather. The Weather application consists of a tab list on the left and a content area on the right.

Weather is a utility application, that opens on top of your current view. To close Weather application and return to your previous view, press the (X) close button in the top right corner.

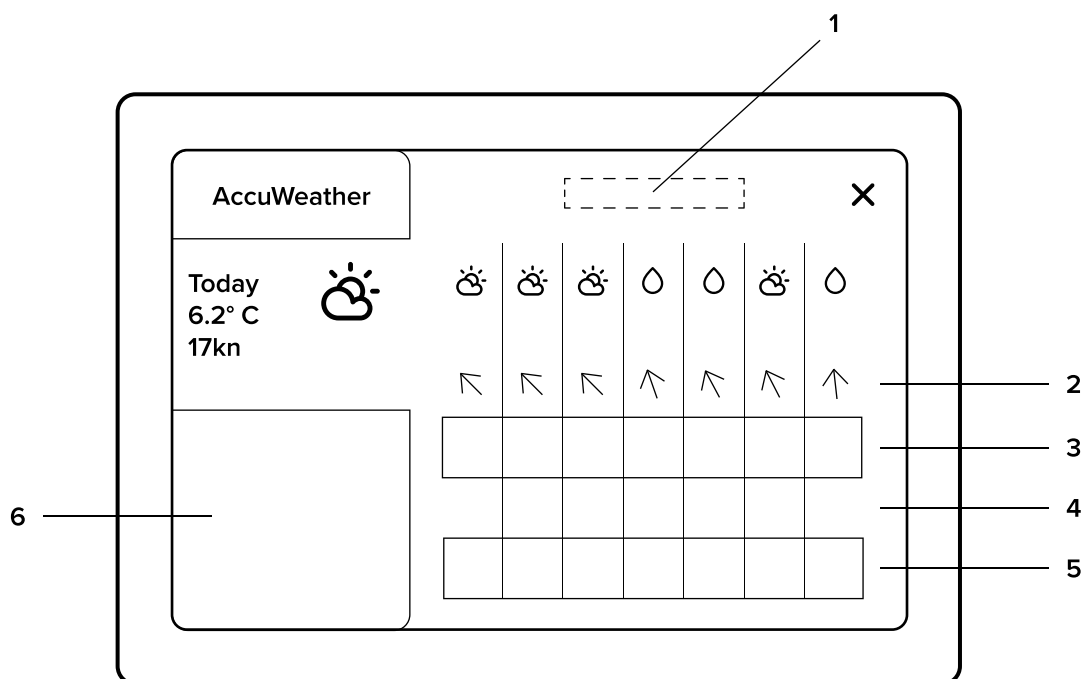

1. Hourly forecast
2. Wind
3. Temperature
4. Rain %
5. Visibility
6. Next days

Weather app

The Tab list on the left features daily overviews for the next 5 days. The Content area on the right features the hourly forecast for the selected date and up to 12 hours ahead.

12. INFO



The Info utility application features all the essential guides for your boat, engine, and Q Display – including this guide. The Info utility also includes useful links, release notes, software licenses, and support information.

Launch the Info application by opening the Home menu and selecting Info. The Info application consists of a Tab list on the left and a Content area on the right.

Info is a utility application, that opens on top of your current view. To close Info application and return to your previous view, press the (X) close button in the top right corner.

The Tab list on the left features all the available guides and other info. In the Tab list, press and select a guide you wish to view.

The Content area on the right displays the selected guide content. Navigate guide content with the controls provided in the guide.

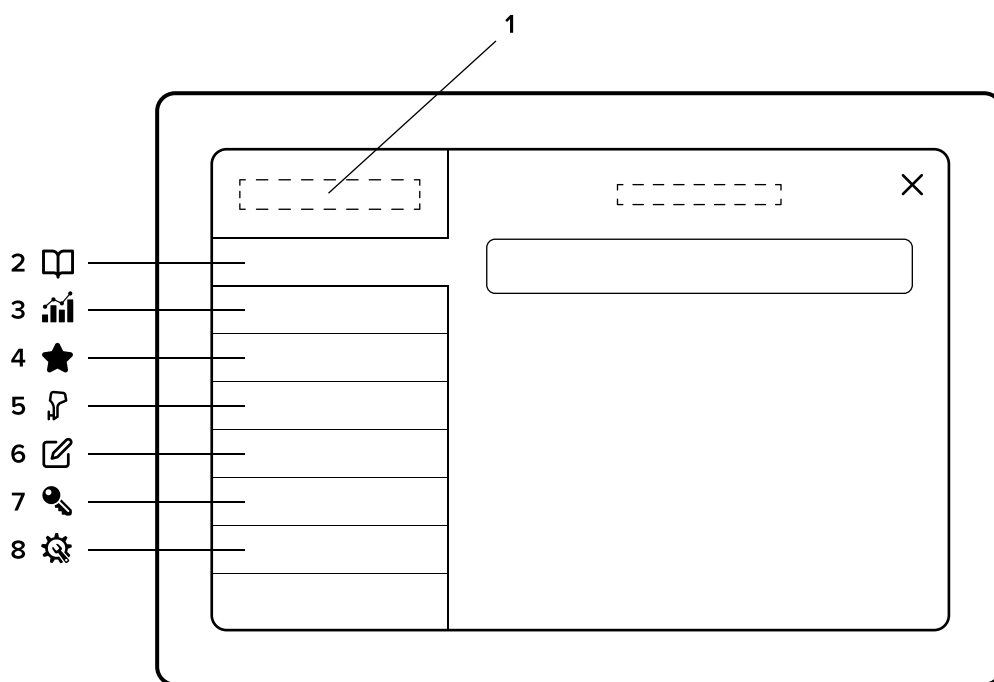

1. Info
2. Guides
3. Statistics
4. Extras
5. Peripherals
6. Release notes
7. Software licenses
8. Support

13. SETTINGS



In the Settings app you can edit and adjust various aspects of the Q Display's functionality. If at any point you need to reset the settings to factory defaults, select 13.11 System reset. It can be found at the bottom of the Settings menu

Launch the Settings application by opening the Home menu and selecting Settings. The Settings application consists of a tab list on the left and a content area on the right.

Settings is a utility application, that opens on top of your current view. To close the Settings application and return to your previous view, press the (X) close button in the top right corner.

Settings app

The Tab list on the left features all the available Settings categories. Press to select a category you wish to view from the Tab list.

The Content area on the right displays the available settings for the selected category.

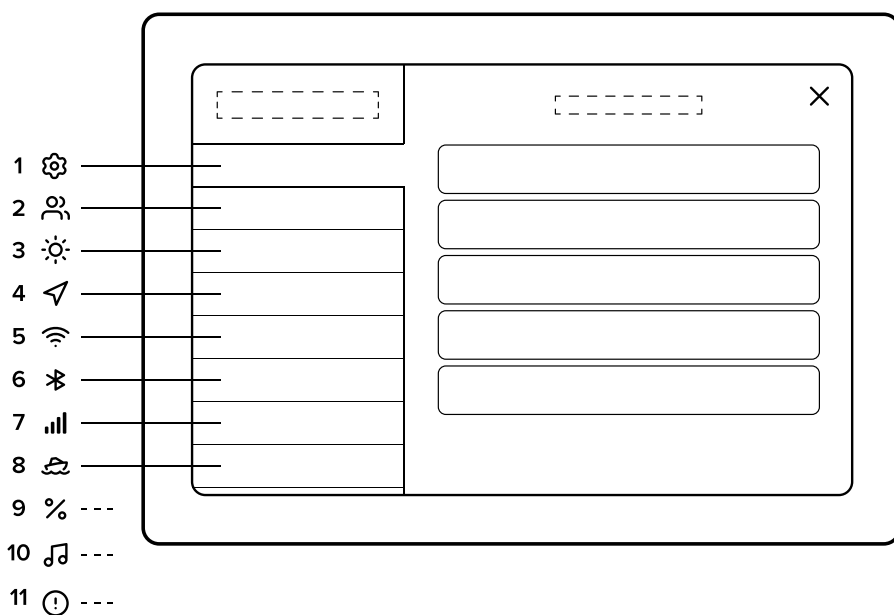

- 1. System settings
- 2. Users
- 3. Display settings
- 4. Navigation
- 5. Wi-Fi
- 6. Bluetooth

- 7. Mobile data
- 8. Boat settings
- 9. Unit settings
- 10. Audio settings
- 11. System reset

13.1 System settings



System settings include all the technical information related to your Q Display.

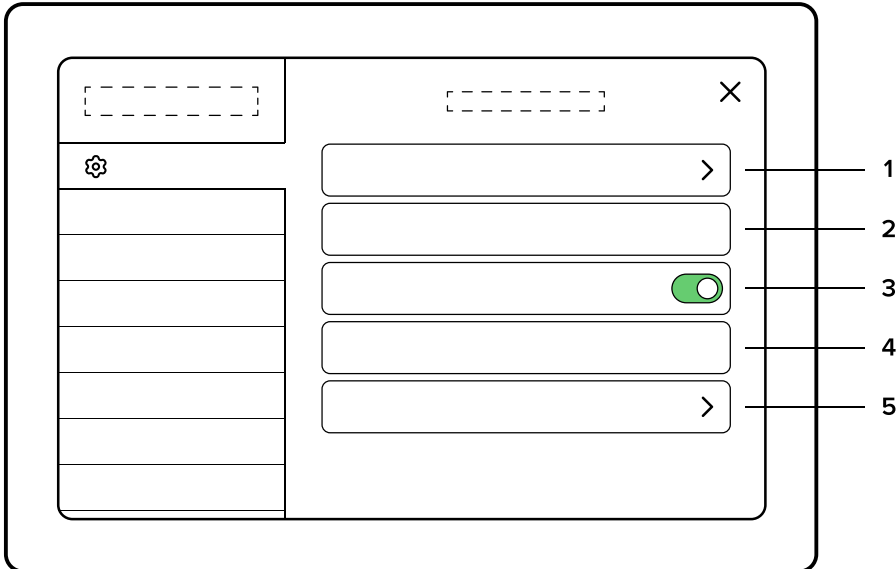

1. System info

The system info section allows you to inspect your Q Display's serial number, software version and other technical data.

2. Language

Select the language of your Q Display. It can be changed to another one anytime you want. Please note that changing the language will restart all your open applications.

3. Time offset/automatic time zone

Time zone is updated automatically from internet. You can switch the automatic feature on/off with a toggle bar.

4. Demonstration mode

Demonstration mode is only meant for showcasing the Q Display. Demonstration mode uses pre-set GPS and engine data, to demonstrate what Q Experience looks like in use.

5. Display QR code

Here you can find the QR code you need to connect your mobile phone with the Q App to your Q Display.

13.2 Users



Users allows you to easily change between sets of saved settings and views. This is especially useful if you have more than one frequent skipper, with different preferences.

Important!

- » User is associated only with settings and views
- » Custom views and settings will be saved only for the currently active user
- » When you create a new user, settings and views will be copied from the currently active user
- » Removing a user will remove all the associated views and settings
- » If you remove the last existing user, it will be replaced by the default Q Experience user, with factory settings and views

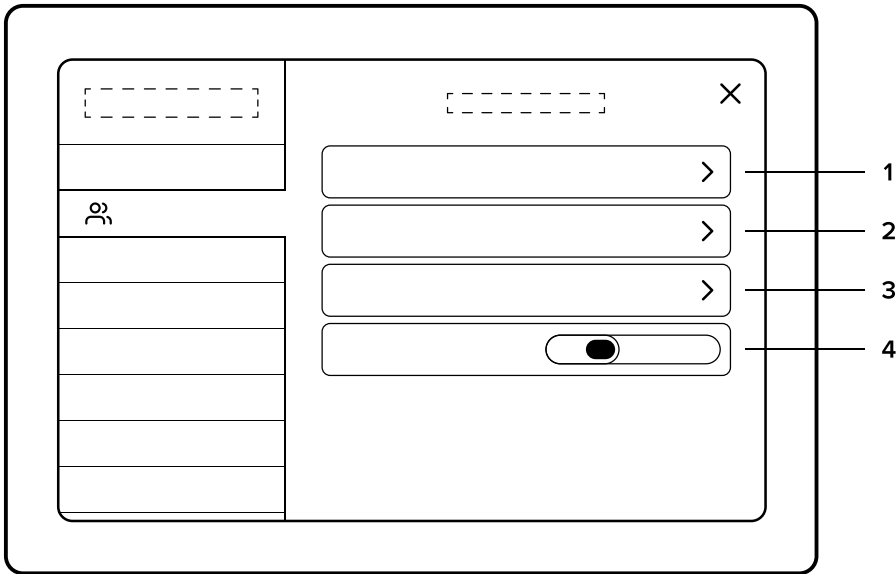

1. Change user

Press the Current user button. Select the user you wish to use from the list.

2. Add new user

Press the New user button. Type the name of the user and press enter. The new user is now created. Settings and views will be duplicated from the user used in use when the new user was created.

Changing the settings and creating new views will only affect the active user.

3. Remove current user

To remove a profile, first activate the profile to be the active profile. When changed, select the Remove current user to remove the profile in use. This action will remove the active profile and all associated views and settings.

4. User selection time

Defines how long will be waited until the last user is selected automatically.

13.3 Display settings



Display settings include adjustments of the Q Display screen and the user interface.

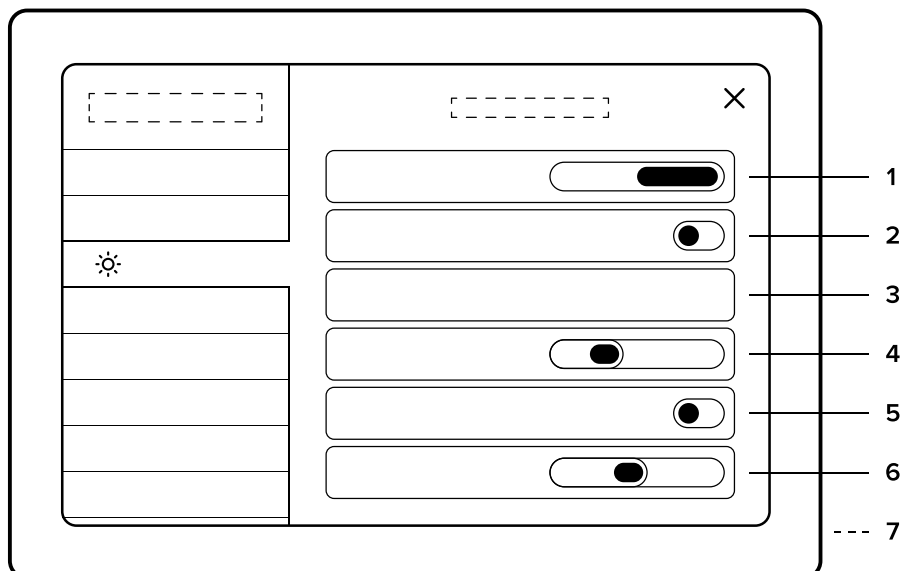

1. Handedness

Select on which side of the side bar the home menu will be positioned.

2. Display brightness

Automatic display brightness will be ON by default. When automatic display brightness is OFF, adjusting brightness will keep it fixed to the preferred value.

3. Theme

Change the display coloring.

4. Automatic night mode

Decrease the value to trigger night mode in darker conditions.

5. Night mode

6. Text size

Adjust the global text size for the menus in your Q Display.

7. No automatic shutdown

Prevent display from shutting down when ignition is turned off.

13.4 Navigation



Navigation settings include everything related to GPS and navigation information.

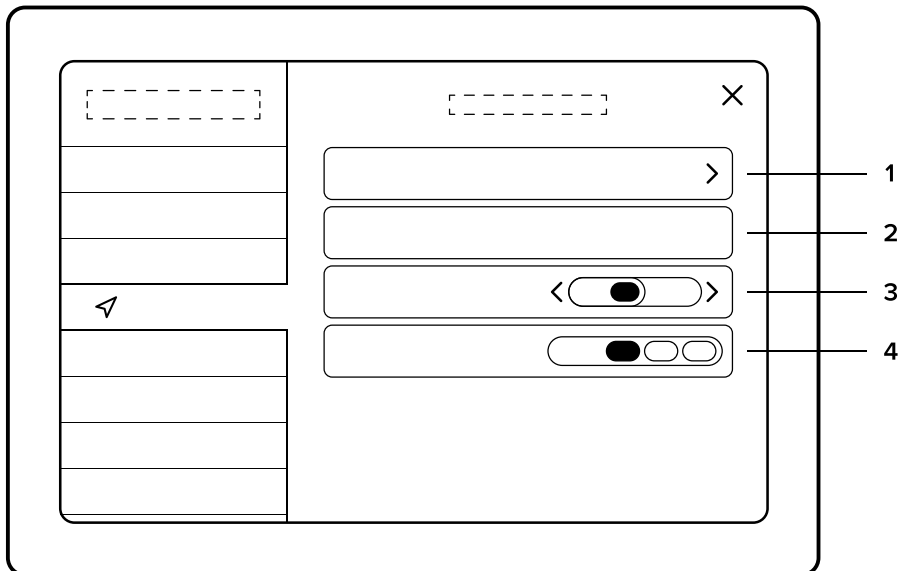

1. GPS information

Inspect your GPS information, satellite, SNR and position info.

2. GPS Source

Set your GPS source to either Internal or NMEA.

The Q Display features an internal GPS antenna that will be used by default. However, in some cases the steering column or other devices around the Q Display may cause too much interference for the GPS signal. In these cases, it is recommended to use an external GPS antenna. The external GPS antenna can be attached to the Q Display via the NMEA network. In this case you should set your GPS source to NMEA.

3. Magnetic heading correction

Correction applied to magnetic heading, e.g. magnetic variation.

4. Trail length

Adjust the trail length show in Chart application.

NOTE: requires Show trail to be activated in Chart settings, see Chapter 5.5 Chart settings.

13.5 WLAN



WLAN allows you to join available networks or share your Q Display's network with other devices via Hotspot.

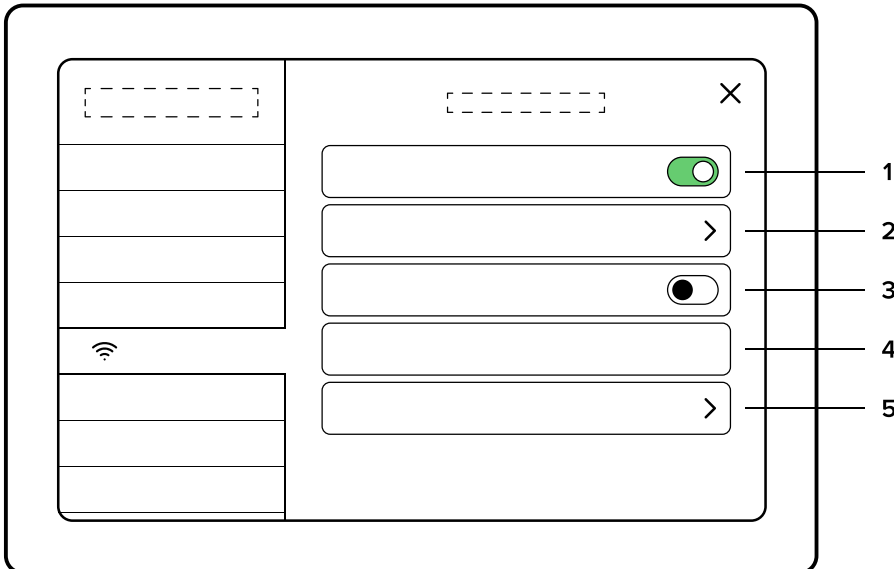

1. WLAN ON/OFF

Toggle WLAN on or off.

When WLAN is activated, you will be able to see available networks and your Q Display will automatically connect to a secure network that you have connected to before.

2. Networks

Inspect and connect to available networks. WLAN must be activated.

3. Hotspot ON/OFF

Toggle your shared network on or off. WLAN must be activated for you to share your network.

4. Hotspot SSID

Hotspot SSID is the name of your shared network.

5. Hotspot password

Hotspot password is the password needed to join your shared network. Choose, or change, your network's password by selecting the Hotspot password.

NOTE: The Hotspot password must be at least 8 characters long.

13.6 Bluetooth



Bluetooth allows you to connect and stream media from external devices to your Q Display.

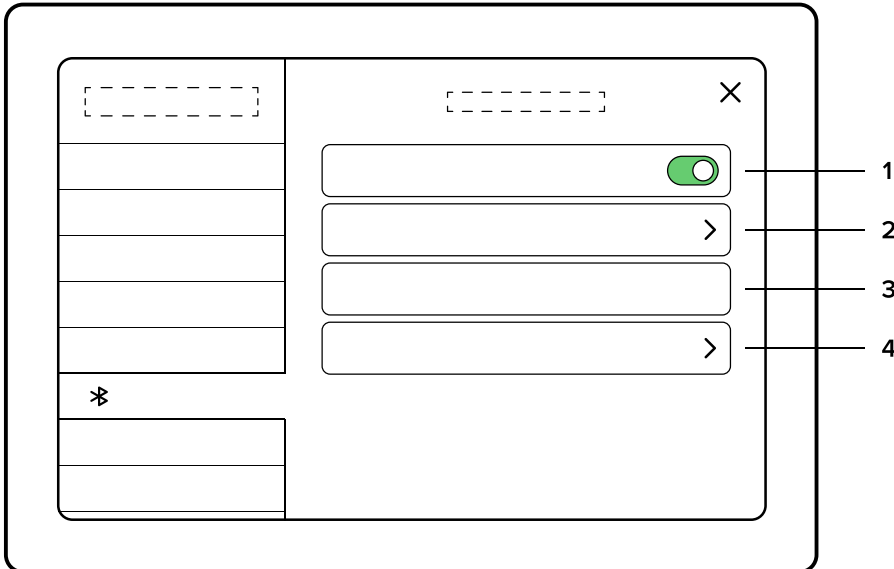

1. Bluetooth toggle

Toggle Bluetooth on or off.

2. Devices

Inspect and connect to available devices via Bluetooth. Press on Devices to see all the devices that have been connected to the Q Display previously, as well as all available devices.

3. Device name

Device name is the name displayed on other devices when trying to connect to your Q Display.

4. Q Remote

Connect your Q remote to your Q Display.

13.7 Mobile data



In Mobile data settings you can insert a Custom APN.

13.8 Boat settings



Boat settings include everything regarding your boat configuration. Boat settings contain the following:

Engine count

Set the number of engines in your boat. Select one or two engines.

Boat draft

Boat draft shows the minimum amount of water required to float the boat without touching the bottom. Set the correct value for safer boating, as the navigation uses this value when calculating safe routes.

Boat width & height

Set width and height of your boat. For safer boating, set the correct measurements, as these values are used to calculate safe routes.

Propulsion type

Set your propulsion type (Fuel or Electricity).

Fuel level stabilization

Fuel level stabilization smooths out the rapid changes in the fuel level readout. Rapid changes may occur in rough seas when the fuel mass is in constant motion. Toggle the stabilization on or off.

Extra packages

Extra packages contain optional application packages that may or may not be activated, depending on your boat's configuration. These packages include Audio, Fishfinder and Radar.

Fuel tank capacity

Fuel tank capacity is the total volume of your boat's fuel tank or tanks. This value is used in fuel related instrument readouts.

Fuel sensor 1 & 2 input

Select the correct fuel sensor inputs from the Boat settings:

- » None
- » A
- » E
- » NMEA

NOTE: if your boat only has one fuel tank, leave fuel sensor 2 blank.

Trim calibration

Trim calibration lets you calibrate your trim level shown in the Dashboard and Compact dashboard widget.

Speed update interval

Speed update interval adjusts how fast the displayed speed value reacts to changes in speed.

13.9 Unit settings



Unit settings allows you to change the various units used in instruments, navigation data etc.

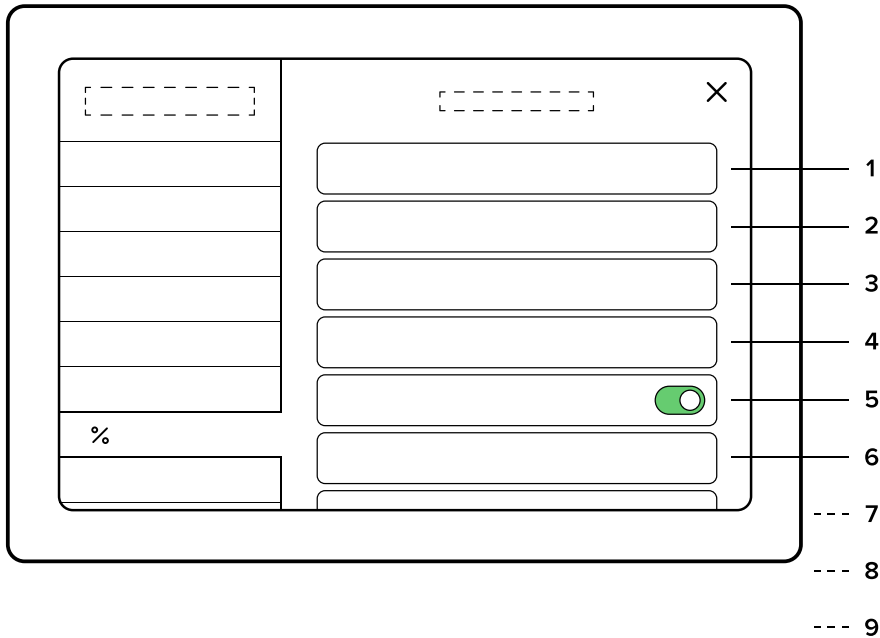

1. Date format

Select date format from the Unit settings:

- » DD.MM.YY
- » DD.MM.YYYY
- » MM.DD.YY
- » MM.DD.YYYY

2. Distance

Set the preferred distance unit:

- » Metric (m, km)
- » Nautical (NM)
- » Imperial (miles)

3. Length

Set the preferred length unit:

- » Metric
- » Imperial

4. Speed

Set the preferred speed unit:

- » Knots (kn)
- » Miles per hour (Mph)
- » Kilometres per hour (Km/h)
- » Meter per second (m/s)

5. Show speed decimal

Add decimal on the speed unit, can be turned on/off

6. Depth

Set the preferred depth unit:

- » Meters (m)
- » Feet (ft)
- » Fathoms (fath)

7. Temperature

Set the preferred temperature unit:

- » Celsius (°C)
- » Fahrenheit (°F)

8. Volume

Set the preferred fuel volume unit:

- » Litres (L)
- » Gallons (gal)

9. Position

Set the preferred position data format:

- » Decimal degrees (DD)
- » Minutes and seconds (DMS)
- » Decimal minutes (DMM)

10. Wind speed

Set the preferred wind speed data format:

- » Meters per second (m/s)
- » Knots (kn)
- » Kilometers per hour (Km/h)

13.10 Audio settings



Audio settings allows you to control audio volume, adjust equalizer, change radio mode between FM and DAB, and adjust your zone volumes.

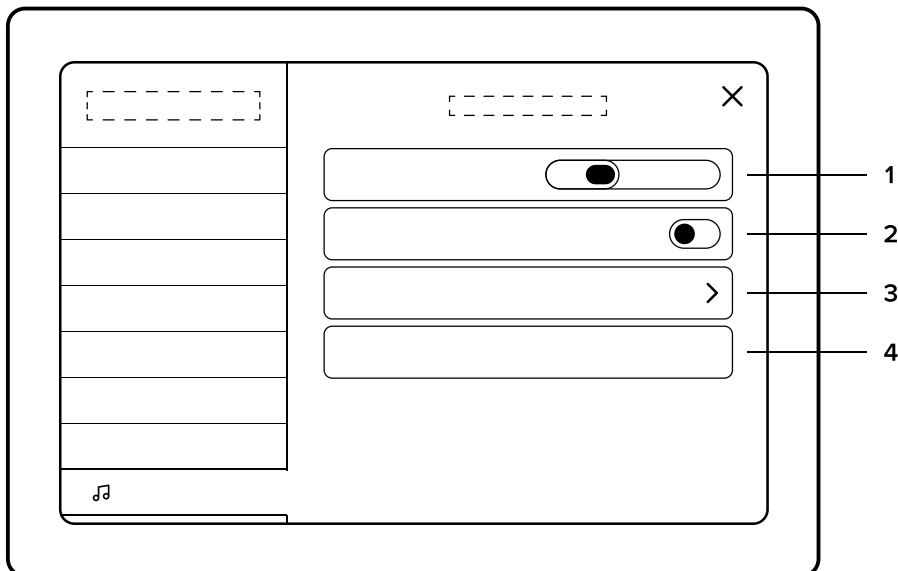

1. Volume

Adjust audio output volume.

2. Zone 1 & 2 volumes

You can adjust the volume in two different zones.

3. Equalizer

Adjust equalizer to fine tune the audio profile to match your listening preferences.

4. Radio mode

Select FM or DAB mode for the radio.

13.11 System reset



System reset allows you to reset Q Display to factory settings.

NOTE: This operation can not be undone. All stored data: settings, views, places, routes, and logs will be deleted.

System reset can be found as the last tab in the Settings application.

14. Q MOBILE APP

Connect your phone to your Q Display using the QR code in the System settings. See more info in Chapter 13.1.5 *Display QR code*.

Q Mobile App is a free mobile application that takes your Q Experience to the next level with added features and boating info. Download the Q Experience Mobile App in your phone's app store.

With the Q Mobile App you get:

- » The Guard feature that keeps your boat safe in the docks
- » Boat info with you 24/7
 - » Inspect battery and fuel level, view boat position and logbook
- » Remote heating to step right into a warm boat

Keep your boat safe with the mobile app's Guard feature. It will alert you if your boat is filling with water or is targeted by a thief. You can see your boat's status from your phone no matter where you are.

You can also control your boat's heating with the Q App. The heater can be turned on remotely in the app, so you can step right into a warm boat when arriving at the harbor. The Q Experience is integrated with Wallas and Webasto heaters.